

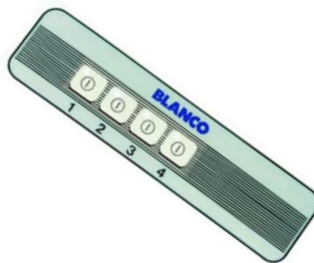

Ersatzteile passend für: BLANCO

B
Passend für Blanco

Ersatzteile passend für Einzelgeräte



G.E.V. Großküchen-Ersatzteil-Vertrieb GmbH

Robert-Koch-Straße 3a
82152 Planegg/München
Deutschland
Telefon: +49 (0)89 745572-0
Telefax: +49 (0)89 745572-82

info@gev-online.de
www.gev-online.de



GEV GmbH Ersatzteile und Zubehör

Kanalstrasse 14
5745 Safenwil
Schweiz
Telefon: +41 (0)62 797 87 70
Telefax: +41 (0)62 797 25 07

info@gev.ch
www.gev.ch

Members of the GEV GROUP

Speisenausgabewagen (Elektro)



Abb.	Bestell-Nr.	Beschreibung	Gerätetyp	Vergl.-Nr.
1	415544	700W/230V Bainmarie	SWE_, SGE_, SAW_, SAG_	0105020
2	415894	150W/230V Wärmefach	STW_	0105454
3	415895	250W/230V Wärmefach	SGE_, SAG_, STW_	0105029



Abb.	Bestell-Nr.	Beschreibung	Gerätetyp	Vergl.-Nr.
1	301083	Schalter	SWE_, SGE_	0105912
2	375714	Thermostat 115°C Bainmarie		0105883
2	375715	Thermostat 85°C Wärmefach	SGE_	0105899
3	111874	Knebel	SWE_, SGE_	0292846

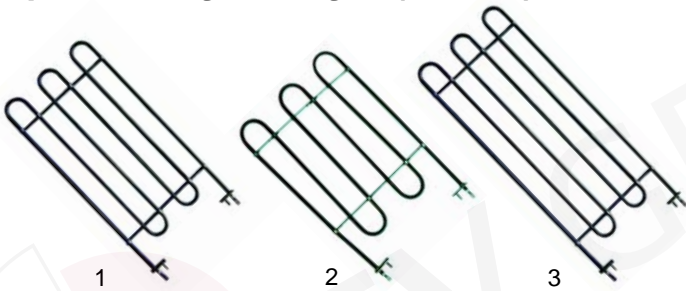

Abb.	Bestell-Nr.	Beschreibung	Gerätetyp	Vergl.-Nr.
1	345235	Schalter		0105798
2	375716	Thermostat Bainmarie	SAW_, SAG_	0105796
2	375239	Thermostat Wärmefach	STW_	0105795
3	111875	Knebel		0146654

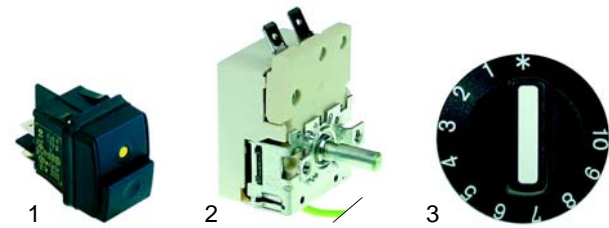

Abb.	Bestell-Nr.	Beschreibung	Gerätetyp	Vergl.-Nr.
1	401387	Tastatur 1-fach		0105746
2	401388	Tastatur 2-fach	SAW_, SAG_	0105747
2	401389	Elektronik 1-fach	STW_	0105748
3	401390	Elektronik 2-fach		0105749

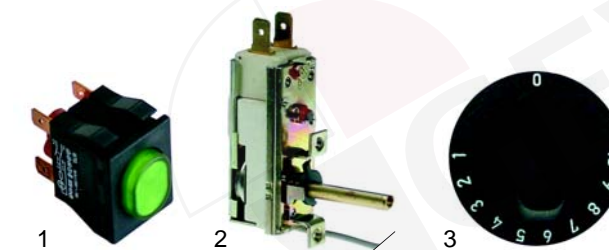

Abb.	Bestell-Nr.	Beschreibung	Gerätetyp	Vergl.-Nr.
1	401391	Frontfolie 1-fach		
2	401392	Frontfolie 2-fach	SAW2/ STW	0146207
3	401394	Frontfolie 3-fach	SAW3	0146208
4	401395	Frontfolie 4-fach	SAG2/ SAW4	0146209
5	401396	Frontfolie 6-fach	SAG3	0146211

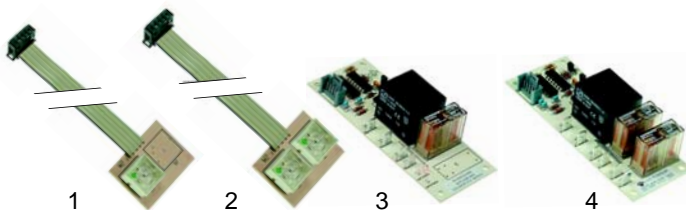

Abb.	B.-Nr.	Beschreibung	Gerätet.	Ver.-Nr.
1	401404	Tastaturfolie, 1-fach	SAW1	-
2	401401	Tastaturfolie, 2-fach, 2 Temperaturen		0146533
3	401403	Tastaturfolie, neutral		0146212
4	401402	Tastaturfolie, neutral		
5	401405	Tastaturfolie, 2-fach, 2 Temperaturen		0146534

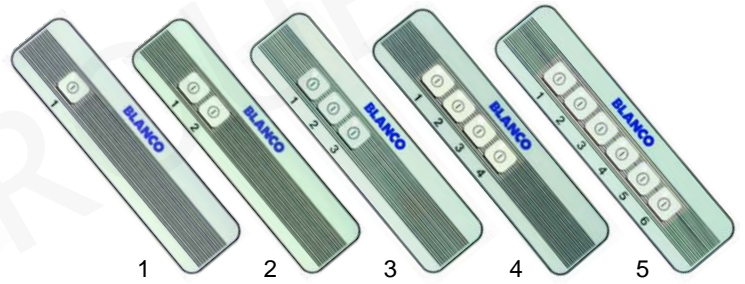

Abb.	Best.-Nr.	Beschreibung	Gerätetyp	Vergl.-Nr.
1	375242	Anlegethermostat, 95°C, Bainmarie	SAW_, SAG_	0105751
2	375243	Anlegethermostat, 80°C, Wärmefach	SAG_, STW_	0105754

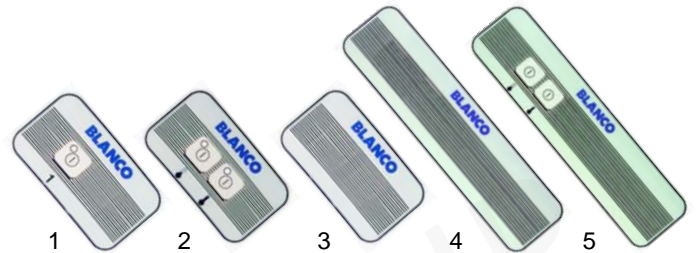

Pos.	Best.-Nr.	Beschreibung	Gerätetyp	Vergl.-Nr.
1	550101	Spiralkabel	SAW_, SAG_ STW_, SEW_, SGE	0105068 0105877

Passend für Blanco

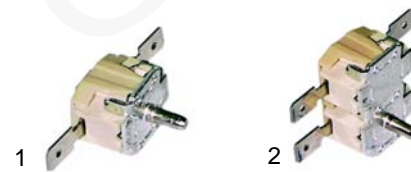
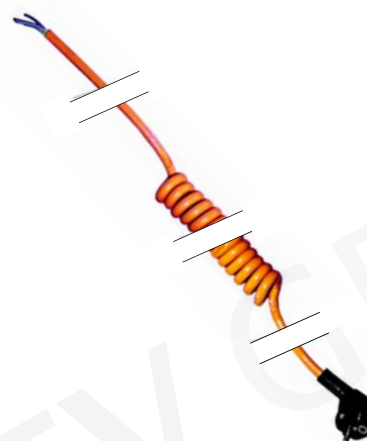

Abb.	Bestell-Nr.	Beschreibung	Gerätetyp	Vergl.-Nr.
1	690899	Abweisrolle		146822
2	700309	Lenkrolle, Ø125mm	SEW_	146802
3	700310	Lenkrolle mit Feststeller, Ø125mm		146803



Abb.	Bestell-Nr.	Beschreibung	Gerätetyp	Vergleichs-Nr.
1	693465	Konsole		146585
2	693466	Stopfen	SEW_	146587
3	690897	Rohr	SGE_	359997



Abb.	Bestell-Nr.	Beschreibung	Gerätetyp	Vergl.-Nr.
1	690898	Stoßbecke		146843
2	690900	Stopfen		362356
3	710004	Lenkrolle mit Feststeller, Ø125mm	SGE_	146806
4	700311	Bockrolle, Ø125mm		146807



Abb.	Bestell-Nr.	Beschreibung	Gerätetyp	Vergl.-Nr.
1	690153	Stoßbecke		0146220
2	690902	Stopfen		0146223
3	710003	Lenkrolle, Ø125mm	SAW_	0146805 0146164
4	710004	Lenkrolle mit Feststeller, Ø125mm		0146806 0146157

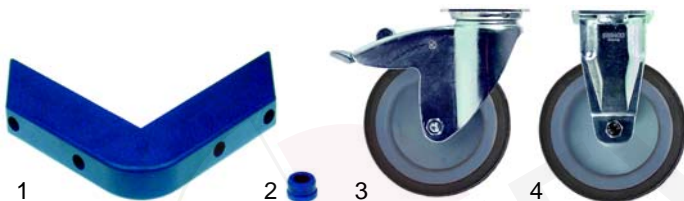

Abb.	Bestell-Nr.	Beschreibung	Gerätetyp	Vergl.-Nr.
1	690904	Griff	SAW_	0146416
2	690905	Seitenteil-Griff	SAG_	0146417
3	690906	Seitenteil/neutral	STW_	0146418
4	690907	Dichtung/Seitenteil		0146203



Abb.	Bestell-Nr.	Beschreibung	Gerätetyp	Vergl.-Nr.
1	700311	Bockrolle, Ø125mm		0146807 0146169
2	710004	Lenkrolle mit Feststeller, Ø125mm	SAW_	0146806
			SAG_	0146150
			STW_	
3	690903	Kugelschnapper		0144345

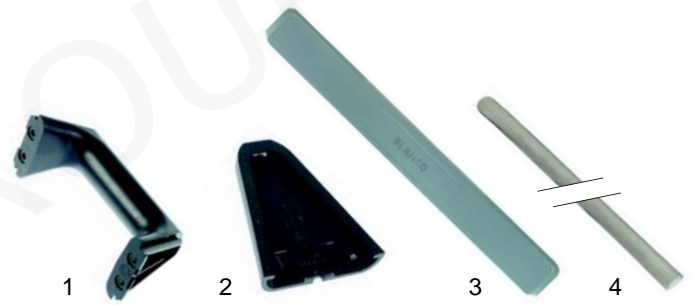

Abb.	Bestell-Nr.	Beschreibung	Gerätetyp	Vergl.-Nr.
1	690911	Seitenteil, neutral	SAW1	0146419
2	690912	Seitenteil	SAG2/4	0276880
3	690913	Seitenteil	SAG3	0276882



Abb.	Bestell-Nr.	Beschreibung	Gerätetyp	Vergl.-Nr.
1	690921	Seitenteil, neutral	SAW1	0276874
2	690922	Seitenteil	SAW2/4	0276878
3	690923	Seitenteil	SAW3	0276879
4	690906	Seitenteil, neutral	Universal	0146418

Tabletttransportwagen (Elektro)

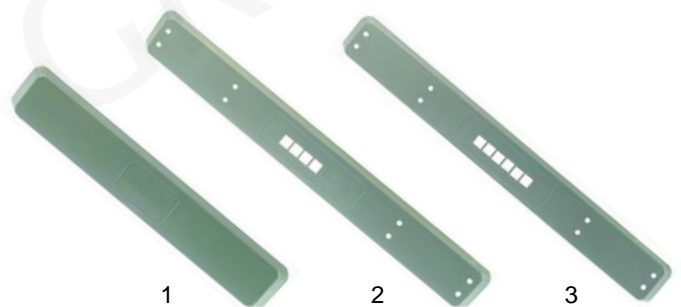

Abb.	Bestell-Nr.	Beschreibung	Gerätetyp	Vergl.-Nr.
1	418278	350W/230V	TTW-F_DB26 TTW-F_DBDG TTW-F_BBEU	105793
2	418284	550W/230V	TTW-F_DB24	105794

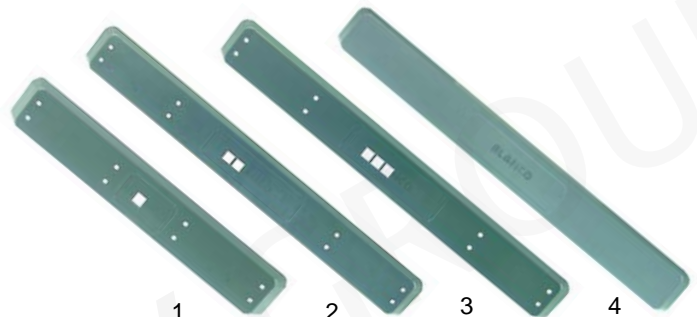

Abb.	Bestell-Nr.	Beschreibung	Gerätetyp	Vergl.-Nr.
1	693465	Griffkonsole		146585
2	693466	Stopfen	TTW-F_	146587
3	690897	Rohr, Ø25mm, 362mm		359998

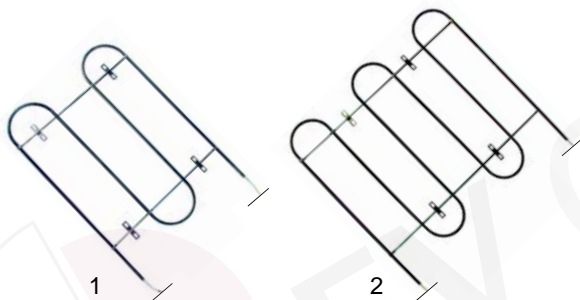

Abb.	Bestell-Nr.	Beschreibung	Gerätetyp	Vergl.-Nr.
1	700235	Lenkrolle, Ø160mm	TTW-F_	146788
2	700236	Bockrolle, Ø160mm		146789

Passend für Blanco



Abb.	Bestell-Nr.	Beschreibung	Gerätetyp	V.-Nr.
1	301083	Schalter		105912
2	375729	Thermostat	TTW-F_	359583
3	111874	Knebel		292846
4	375730	Sicherheitsthermostat 115°C		105803

Caldofreddo (Elektro)



Abb.	Bestell-Nr.	Beschreibung	Gerätetyp	Vergl.-Nr.
1	415893	1800W/230V		0105708
2	601267	Ventilator	CF_	0106188
3	301083	Schalter		0105912

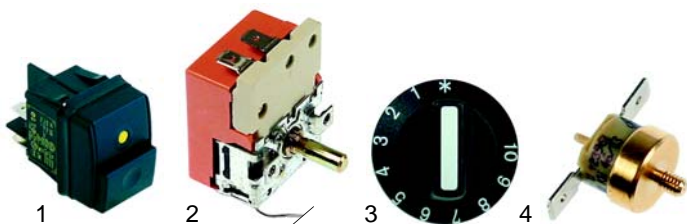

Abb.	Bestell-Nr.	Beschreibung	Gerätetyp	Vergl.-Nr.
1	379054	Transformator		0105791
2	379559	Elektr. Regler	TTW-F_	0106386 0105790
3	379052	Fühler		0105788

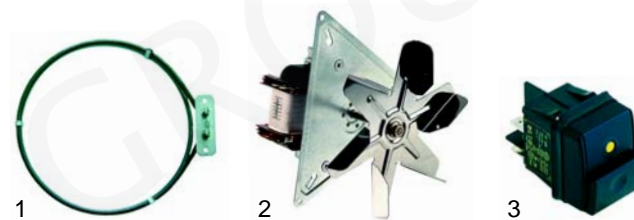

Abb.	Bestell-Nr.	Beschreibung	Gerätetyp	Vergl.-Nr.
1	379562	Elektr. Regler		0106189
2	379052	Fühler		0105788
3	379054	Transformator	CF_	0105791
4	375732	Sicherheitsthermostat, 150°C		0297578



Abb.	Bestell-Nr.	Beschreibung	Gerätetyp	Vergl.-Nr.
1	690910	Türgriff		362976 146624
2	690909	Feder	TTW-F_	147251
3	690916	Riegel		292360
4	690917	Schließzylinder		144350

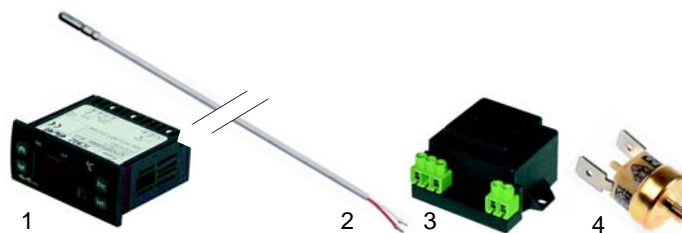

Abb.	Bestell-Nr.	Beschreibung	Gerätetyp	Vergl.-Nr.
1	690924	Stoßbocke		0146908
2	690902	Stopfen		0146223
3	693465	Konsole	CF__	0146585
4	693466	Stopfen		0146587
5	690897	Rohr, Ø25mm, 362mm		0359998



Abb.	Bestell-Nr.	Beschreibung	Gerätetyp	Vergl.-Nr.
1	700235	Lenkrolle, Ø160mm	CF__	146788
2	700236	Bockrolle, Ø160mm		146789

Bankettwagen (Elektro)



Abb.	Bestell-Nr.	Beschreibung	Gerätetyp	Vergl.-Nr.
1	415596	1500W/230V		0105439
2	601254	Ventilator kpl.	BW__	0105913
3	390311	Sicherheitsthermostat, 135°C		0105805



Abb.	Bestell-Nr.	Beschreibung	Gerätetyp	Vergl.-Nr.
1	345235	Schalter	BW__(Alt)	0105798
2	301083	Schalter	BW__(Neu)	0105912

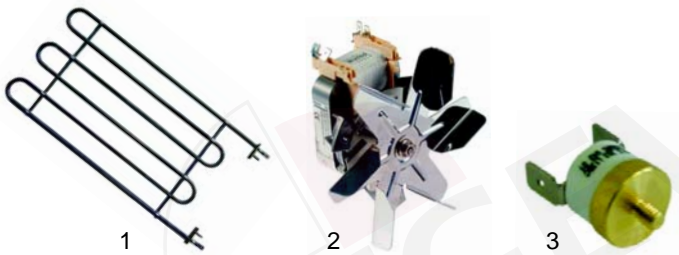

Abb.	Bestell-Nr.	Beschreibung	Gerätetyp	Vergl.-Nr.
1	379054	Transformator 12V		0105791
2	379559	Elektronikregler	BW__	0105790
3	379052	Fühler PTC		0105788

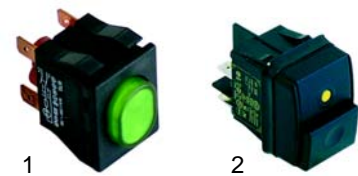

Abb.	Bestell-Nr.	Beschreibung	Gerätetyp	Vergl.-Nr.
1	700314	Lenkrolle, Ø200mm		0145132
2	700315	Lenkrolle mit Feststeller, Ø200mm	BW__	0145133
3	700313	Bockrolle, Ø200mm		0145130



Abb.	Bestell-Nr.	Beschreibung	Gerätetyp	Vergl.-Nr.
1	693465	Konsole		0146585
2	693466	Stopfen		0146587
3	690897	Rohr, Ø25mm, 362mm	BW__	0292297 0359998

Stapelgeräte/Tellerspender (Elektro)



Abb.	Bestell-Nr.	Beschreibung	Gerätetyp	Vergl.-Nr.
1	415706	275W/230V	RHE (bis 1995)	0105700
2	415714	400W/230V		0105677



Abb.	Bestell-Nr.	Beschreibung	Gerätetyp	Vergl.-Nr.
1	301069	Schalter	RHE (bis 1995)	0105674
2	301064	Haube		0105678
3	390079	Thermostat		0105675
4	111893	Knebel		



Abb.	Best.-Nr.	Beschreibung	Gerätetyp	Ver.-Nr.
1	415893	1800W/230V	2SHV (bis 1992) 2SHV_ (ab 1995)	0105672 0105708
2	601268	Ventilator kpl.	2SHV_	0105671
3	375733	Thermostat, 80°C/63°C		0105733

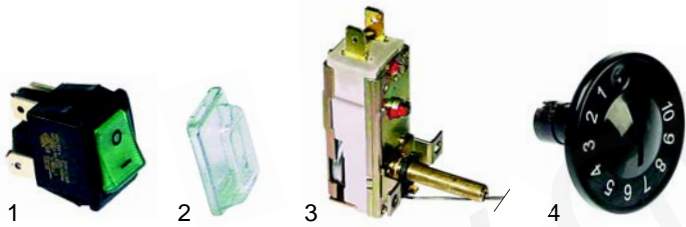

Abb.	Bestell-Nr.	Beschreibung	Gerätetyp	Vergl.-Nr.
1	418285	275W/230V	RHE (ab 1995)	0105911
2	301083	Schalter		0105912



Abb.	B.-Nr.	Beschreibung	Gerätetyp	Ver.-Nr.
1	401388	Tastatur		0105747
2	401401	Tastatur Folie	_SHE (von '92 bis '95)	0146533
3	401405	Elektronik, 2-fach, 2 Temperaturen	2SHME_ (von '92 bis '95) 2SHV_ (von '92 bis '95)	0146534
4	401399	Elektronik, 2-fach, 2 Temperaturen		0105771



Abb.	Bestell-Nr.	Beschreibung	Gerätetyp	Vergl.-Nr.
1	375239	Thermostat	RHE (ab 1995)	0105795
2	111893	Knebel		0105675
3	390311	Sicherheitsthermostat, 135°C		0105805

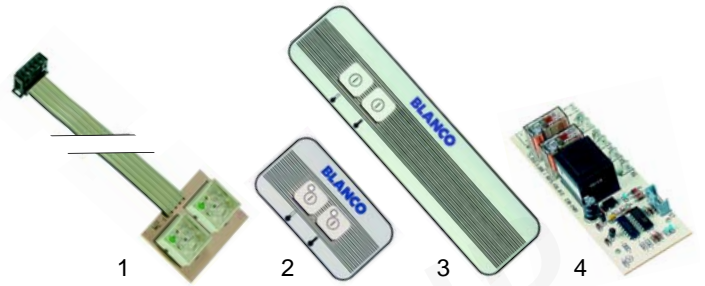

Abb.	Bestell-Nr.	Beschreibung	Gerätetyp	Ver.-Nr.
1	375406	Thermostat	_SHE_ (bis 1992)	0105127
2	110119	Knebel	2SHME_ (bis 1992), 2SHV_ (bis 1992)	0105373
3	359148	Signallampe		0105188



Abb.	Bestell-Nr.	Beschreibung	Gerätetyp	Vergl.-Nr.
1	415910	900W/230V	SHE (bis 1995) 2SHME (bis 1995)	0105723
2	415892	900W/230V	_SHE (ab 1995) 2SHME (ab 1995)	0146753

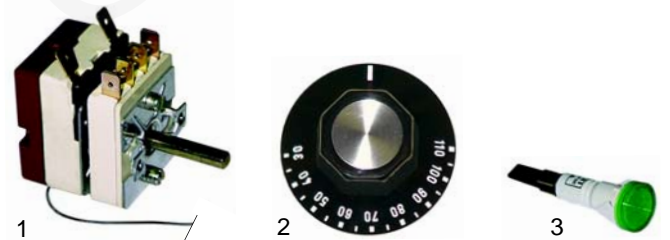

Abb.	B.-Nr.	Beschreibung	Gerätetyp	Ver.-Nr.
1	375241	Thermostat		0105797
2	111875	Knebel	_SHE_ (ab 1995) 2SHME_ (ab 1995),	0146654
3	390311	Sich.-thermostat, 135°C	2SHV_ (ab 1995)	0105805
4	345235	Schalter		0105798

B

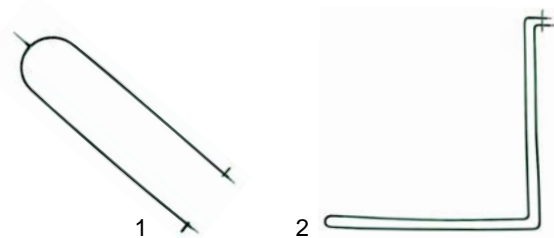
Passend für Blanco



Abb.	B.-Nr.	Beschreibung	Gerätetyp	Ver.-Nr.
1	690925	Griffkonsole	(bis 1992)	0144041
2	690928	Rohr, Ø25mm, 708mm, kürzbar	RE_, RHG, SE_, SHG, SHMG, VHV-, CHV_-, CHV-U, CE, LEB, CEV, CEBH, UNI, UNI-U	0295344
3	690378	Stoßbecke		0145429



Abb.	B.-Nr.	Beschreibung	Gerätetyp	Ver.-Nr.
1	710003	Lenkrolle, Ø125mm	(ab 1995)	0146805
2	710004	Lenkrolle mit Feststeller, Ø125mm	RE_, RHG, SE_, SHG, SHMG, VHV-, CHV_-, CHV-U, CE, LEB, CEV, CEBH, UNI, UNI-U	0146806
3	690153	Stoßbecke		0146220
4	690902	Stopfen		0146223

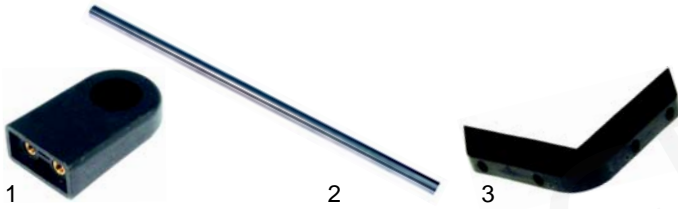

Abb.	B.-Nr.	Beschreibung	Gerätetyp	Ver.-Nr.
1	710003	Lenkrolle, Ø125mm	(ab 1992)	0146805
2	710004	Lenkrolle mit Feststeller, Ø125mm	RE_, RHG, SE_, SHG, SHMG, VHV-, CHV_-, CHV-U, CE, LEB, CEV, CEBH, UNI, UNI-U	0145058
				0146806
				0145059



Abb.	Bestell-Nr.	Beschreibung	Gerätetyp	Ver.-Nr.
1	690151	Zugfeder, 49mm		0146304
2	690150	Zugfeder, 89mm	Universal	0146305
3	690152	Zugfeder, 209 mm (Warm- und Kaltgeräte)		0146303
				0146302



Abb.	B.-Nr.	Beschreibung	Gerätetyp	Ver.-Nr.
1	690911	Seitenteil rechts, 454mm	(ab 1992)	0146419
2	690926	Seitenteil links, 454mm	RE_, RHG, SE_, SHG, SHMG, VHV-, CHV_-, CHV-U, CE, LEB, CEV, CEBH, UNI, UNI-U	0276875
3	690906	Seitenteil rechts, 654mm		0146418
4	690922	Seitenteil link, 654mm		0146412
				0276878

Thermoport (Elektro)

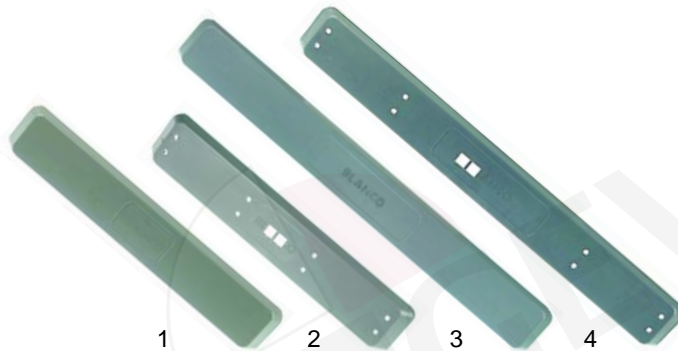

Abb.	Bestell-Nr.	Beschreibung	Gerätetyp	Ver.-Nr.
1	415218	500W/230V, 320mm		0252477
2	390104	Anlegethermostat, 95°C		0105483

Geräte mit Elektronik

Seitenteile

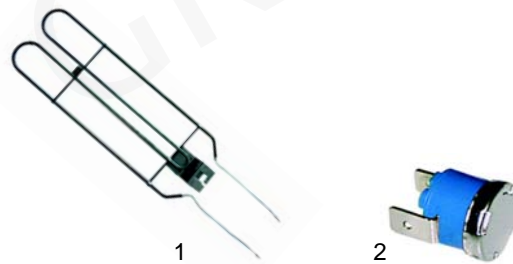

Abb.	B.-Nr.	Beschreibung	Gerätetyp	Ver.-Nr.
1	710003	Lenkrolle, Ø125mm	(von 1992 - 1995)	0146805
				0146162
2	710004	Lenkrolle mit Feststeller, Ø125mm	SHMG, VHV-, CHV_-, CHV-U, CE, LEB, CEV, CEBH, UNI, UNI-U	0146806
				0146155
3	690153	Stoßbecke		0146220
4	690902	Stopfen		0146223



Abb.	Bestell-Nr.	Beschreibung	Gerätetyp	Ver.-Nr.
1	690921	Seitenteil, 1-fach, 454mm		0276874
2	690926	Seitenteil, 2-fach, 454mm 2 Temperaturen		0276875
3	690911	Seitenteil/neutral, 454mm		0146419

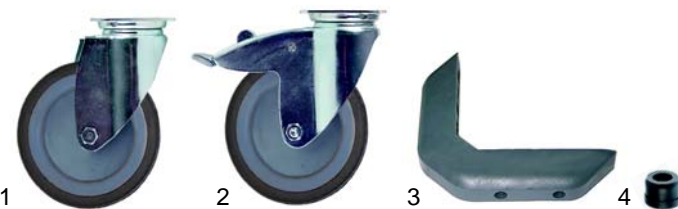

Abb.	Bestell-Nr.	Beschreibung	Gerätetyp	Ver.-Nr.
1	690927	Seitenteil, 1-fach, 654mm		0276877
2	690922	Seitenteil, 2-fach, 654mm		0276878
3	690923	Seitenteil, 3-fach, 654mm		0276879



Abb.	Bestell-Nr.	Beschreibung	Gerätetyp	Vergl.-Nr.
1	401391	Frontfolie, 1-fach		0146206
2	401392	Frontfolie, 2-fach		0146207
3	401394	Frontfolie, 3-fach		0146208
4	401395	Frontfolie, 4-fach		0146209
5	401396	Frontfolie, 6-fach		0146211

B

Passend für Blanco

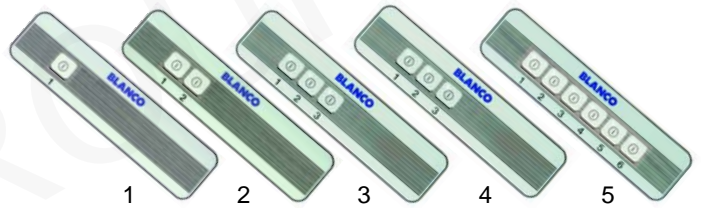

Abb.	Bestell-Nr.	Beschreibung	Gerätetyp	Ver.-Nr.
1	690912	Seitenteil, 4-fach, 654mm		0276880
2	690913	Seitenteil, 6-fach, 654mm		0276882
3	690906	Seitenteil/neutral, 654mm		0146418

Tastaturen



Abb.	Bestell-Nr.	Beschreibung	Gerätetyp	Vergl.-Nr.
1	401387	Tastatur, 1-fach		0105746
2	401388	Tastatur, 2-fach		0105747

Frontfolien

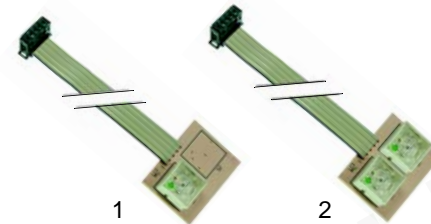

Abb.	Bestell-Nr.	Beschreibung	Gerätetyp	Vergl.-Nr.
1	401403	Frontfolie, neutral		0146212
2	401404	Frontfolie, 1-fach		-
3	401401	Frontfolie, 2-fach, 2 Temperaturen		0146533
4	401402	Frontfolie, neutral		-
5	401405	Frontfolie, 2-fach, 2 Temperaturen		0143534

Elektronik

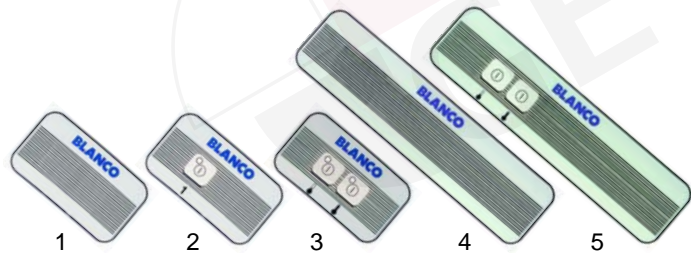

Abb.	Bestell-Nr.	Beschreibung	Gerätetyp	Vergl.-Nr.
1	401389	Elektronik, 1-fach		0105748
2	401390	Elektronik, 2-fach		0105749
3	401399	Elektronik, 2-fach		0105771

Thermostate



Abb.	Bestell-Nr.	Beschreibung	Gerätetyp	Ver.-Nr.
1	375242	95°C		0105751
2	375733	2 Temperaturen 80°C/ 63°C		0105733
3	375243	Thermostat 80°C Sicher.-thermostat, 105°C		0105754

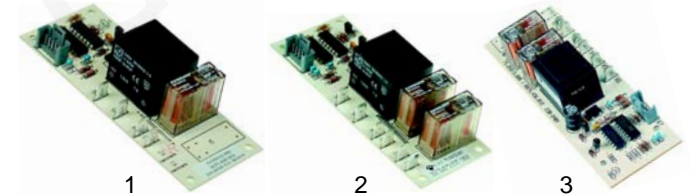