



Enthärter

Seite 386



Wasserarmaturen, Geschirrbrausen

Seite 392



Gerätereiniger und Schlauchroller

Seite 408

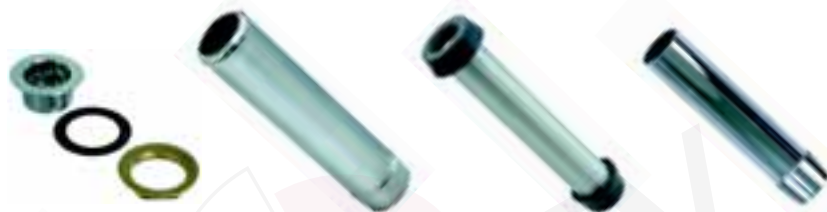

Überlaufrohre

Seite 412

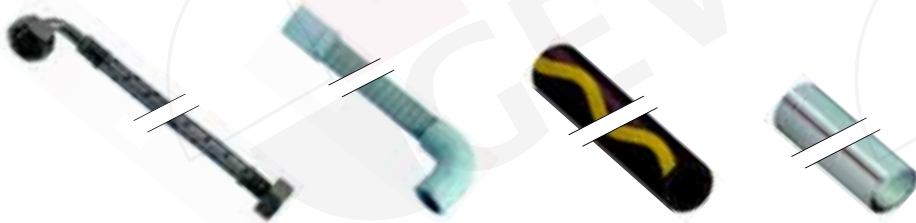

Schläuche

Seite 413



Fittings und Kugelhähne,
Ablaufsysteme

Seite 416



Körbe

Seite 424

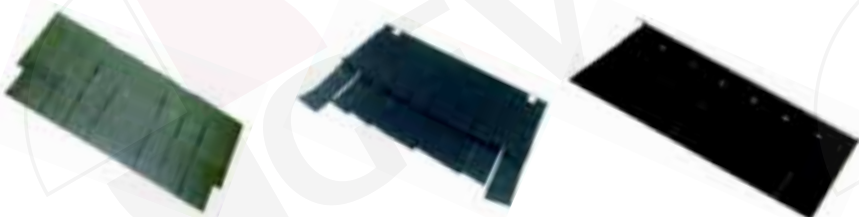

Vorhänge

Seite 429

Manuelle Wasserenthärter

Legende:

FI Flascheninhalt in Lit.
HI Harzmengeninhalte in Lit.
SV Salzverbrauch pro Regen.
K Kapazität bei 17°DH

Technische Daten:

Betriebsdruck: max. 7bar
 Wassertemperatur: 2 bis 40°C
 Anschluss: 3/8"



Abb.	B.-Nr.	FI	HI	SV	K	HxD (mm)
1	530120	8 L.	5,8 L.	1 kg	1000 L.	185 x 415
1	530121	12 L.	9 L.	1,5 kg	1500 L.	185 x 515
1	530126	16 L.	12 L.	2 kg	2100 L.	185 x 615
1	530127	20 L.	15 L.	3 kg	3100 L.	185 x 915
2	530122	8 L.	5,8 L.	1 kg	1000 L.	185 x 415
2	530123	12 L.	9 L.	1,5 kg	1500 L.	185 x 515
2	530124	16 L.	12 L.	2 kg	2100 L.	185 x 615
2	530125	20 L.	15 L.	3 kg	3100 L.	185 x 915
3	530195	7 L.	5 L.	1 kg	1100 L.	175 x 380
3	530196	10 L.	7 L.	1,5 kg	1500 L.	175 x 420
3	530197	12 L.	8 L.	2 kg	1700 L.	175 x 510

Ersatzteile MB/ MM



Abb.	Bestell-Nr.	Beschreibung	Für Typ
1	520133	Ventil, 3/8"	MB
2	520135	Bypassventil	MM
3	530328	Düse, M6 x 1	MB
4	520213	Reduzierung, 3/8" - 3/4"	MB, MM
5	520214	Reduzierung, 3/8" - 3/4"	MB, MM

Ersatzteile MB/ MM



Abb.	Bestell-Nr.	Beschreibung	Für Typ
1	520130	Deckel/ kpl.	MB, MM
2	520131	O-Ring (Deckel)	MB, MM
3	530128	Plastsockel	MB, MM



Abb.	Bestell-Nr.	Beschreibung	Für Typ
1	520132	Filter/ oben	MB
1	520269	Filter/ oben	MM
2	520134	Filter/ unten	MB
2	520140	Filter/ unten	MM 8L
2	520141	Filter/ unten	MM 12L
2	520142	Filter/ unten	MM16L
2	520143	Filter/ unten	MM20L



Abb.	Bestell-Nr.	Beschreibung
1	520136	Harz Dowex HCR -S/S, 25 Liter
1	530240	Harz Purolite 25 Liter
2	540620	Gesamthärte-Maßbesteck
2	540621	Karbonathärte-Maßbesteck/

Automatische Wasserenthärter

Legende:

FI Flascheninhalt in Lit.
HI Harzmengeninhalte in Lit.
SV Salzverbrauch pro Regen.
KS Kapazität Salzbehälter
K Kapazität bei 17°DH

Typ AZB

Technische Daten:
 Betriebsdruck: 2 bis 5 bar
 Temperatur: 2 bis 40°C
 Versorgung: 230V/50Hz
 Intervall: 1 bis 6 Tage
 Steuerung: Bores/ Zeitsteuerung



Abb.	B.-Nr.	FI	HI	SV	KS	K	BxTxH (mm)
1	530138	8 L.	6 L.	1,1 kg	20 kg	1300 L.	230 x 430 x 490
2	530139	12 L.	9 L.	1,5 kg	50 kg	1900 L.	310 x 430 x 590

Typ AZA

Technische Daten:

Betriebsdruck: 1,8 bis 7 bar
Temperatur: 2 bis 45°C

Versorgung: 230V/50Hz
Intervall: 1 bis 6 Tage
Steuerung: Autotrol/ Zeitsteuerung



Abb.	B.-Nr.	FI	HI	SV	KS	K	BxTxH (mm)
1	530130	8 L.	6 L.	1,1 kg	20 kg	1300 L.	245 x 480 x 560
2	530131	12 L.	9 L.	1,5 kg	30 kg	1950 L.	310 x 430 x 660
2	530132	20 L.	15 L.	2,7 kg	70 kg	3250 L.	310 x 430 x 1100

Typ AVA

Technische Daten:

Betriebsdruck: 2 bis 6 bar
Temperatur: 2 bis 40°C

Versorgung: 230V/50Hz
Steuerung: Autotrol/ Volumetrisch

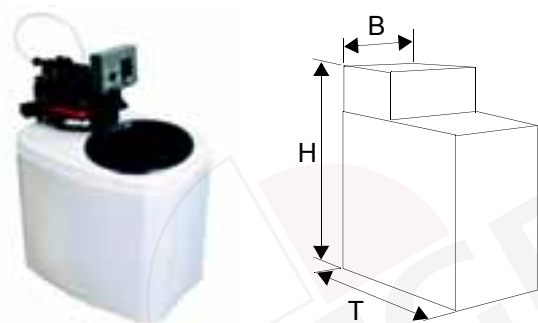

Pos.	B.-Nr.	FI	HI	SV	KS	K	BxTxH (mm)
1	530133	12 L.	9 L.	1,5 kg	30 kg	1900 L.	310 x 490 x 660
2	530134	20 L.	15 L.	2,7 kg	70 kg	3200 L.	310 x 490 x 1100

Typ AZFW

Technische Daten:

Betriebsdruck: 2 bis 6 bar
Temperatur: 2 bis 60°C

Versorgung: 230V/50Hz
Intervall: 1 bis 6 Tage
Steuerung: Fleck/ Zeitsteuerung



Pos.	B.-Nr.	FI	HI	SV	KS	K	BxTxH (mm)
1	530190	12 L.	9 L.	1,5 kg	30 kg	1900 L.	310 x 490 x 660
2	530191	20 L.	15 L.	2,7 kg	70 kg	3200 L.	310 x 490 x 1100

Typ AZV

Technische Daten:

Betriebsdruck: 2 bis 8 bar
Temperatur: 5 bis 15°C

Versorgung: 230V/50Hz
Intervall: 1 bis 6 Tage
Steuerung: DEV



Abb.	B.-Nr.	FI	HI	SV	KS	K	BxTxH (mm)
1	530129	8 L.	5,8 L.	1 kg	20 kg	1000 L.	245 x 430 x 490

Ersatzteile AZB



Abb.	Bestell-Nr.	Beschreibung
1	530304	Ventiloberteil/ kpl.
2	530303	Abdeckung
3	530300	Transformator, 230V/ 24V - 12VA
4	530301	Getriebemotor
5	530302	Mikroschalter

Ersatzteile AZA, AVA



Abb.	Bestell-Nr.	Beschreibung	Typ
1	530032	Ventiloberteil/ kpl., Zeitsteuerung	AZA
2	530034	Timer, Zeitsteuerung	AZA



Abb.	Bestell-Nr.	Beschreibung	Typ
1	530033	Ventiloberteil/ kpl., volumetrisch	AVA
2	530040	Timer, volumetrisch	AVA
3	530042	Zähladapter	AVA

Ersatzteile Universal

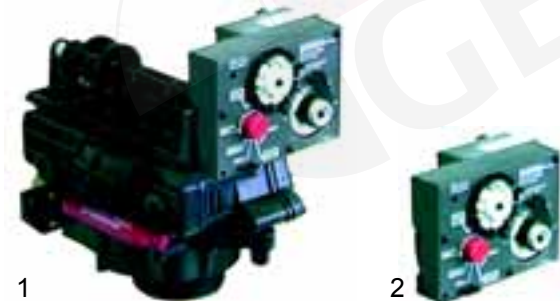

ohne Abbildung!

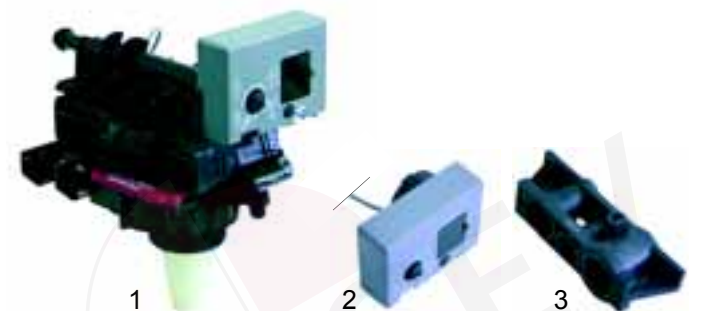
Abb.	Bestell-Nr.	Beschreibung
1	530324	Kit-Membrane
2	530325	Kit-Bypass

Ersatzteile AZFW



Abb.	Bestell-Nr.	Beschreibung
1	530267	Ventiloberteil/ kpl.
2	530266	Ventiloberteil



Abb.	Bestell-Nr.	Beschreibung
1	530260	Elektronik
2	530261	Tasten
3	530262	Abdeckung



Abb.	Bestell-Nr.	Beschreibung
1	530263	Transformator, 230V/ 24V
2	530264	Getriebemotor, 24V
2	530268	Getriebemotor, 230V

Ersatzteile AZFW

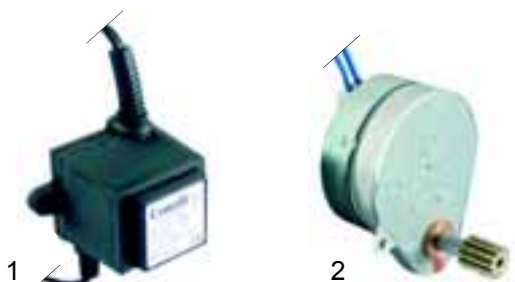

ohne Abbildung!

Abb.	Bestell-Nr.	Beschreibung
1	530041	Transformator, 230V/ 12V, 6VA
2	530330	Getriebemotor, 12VAC
3	520300	Bypass-Ventil
4	520318	O-Ring-Satz



ohne Abb.!

Abb.	Bestell-Nr.	Beschreibung
1	530035	Ventiloberteil
2	530036	Nockenwelle
3	530037	O-Ring-Satz
4	530038	Luftventilhaube
5	530026	O-Ring (Lufthaube)



Abb.	Bestell-Nr.	Beschreibung
1	530311	O-Ring
2	530312	Filter
3	530316	Kugel
4	530315	O-Ring
5	530313	Rückspülventil (7)
5	530314	Rückspülventil (8)
6	530317	Injector (weiß)
6	530318	Injector (blau)
6	530319	Injector (rot)
7	530320	Kappe
7	530321	Kappe
7	530322	Kappe
8	530323	Solemengenregler

Ersatzteile DEV



Abb.	Bestell-Nr.	Beschreibung
1	530135	Salzbehälter
2	530136	Flaschenüberzug
3	520309	CNS-Flasche
4	530128	Plastiksockel
5	530030	Abdeckung
6	520138	Deckel

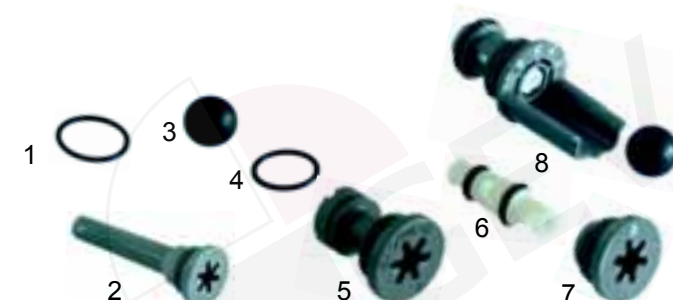

Abb.	Bestell-Nr.	Beschreibung
1	520301	Verschraubung Sauglanze Salzbehälter/
2	520302	Sauglanze Salzbehälter
3	520307	Verschraubung Behälter
4	520315	Sauglanze CNS-Flasche/
5	520303	Nylonschlauch
6	520306	Überlaufverschraubung



Abb.	Bestell-Nr.	Beschreibung
1	530029	Ventiloberteil
2	520305	Elektronikbox, 230V

Ersatzteile DEV



Abb.	Bestell-Nr.	Beschreibung
1	530043	Magnetspule
2	530277	Ventilkörper
3	530287	Solemengenregler
4	530282	O-Ring
5	530283	O-Ring
6	530294	Düse
7	530286	Oberteil
8	530293	O-Ring
9	530284	O-Ring
10	530288	O-Ring

Harze

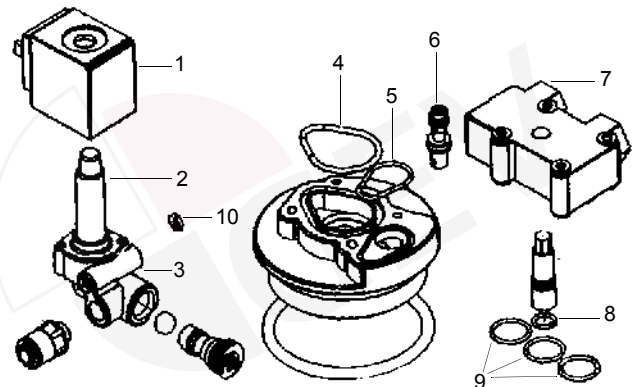

Pos.	Bestell-Nr.	Beschreibung
1	520136	Dowex HCR -S/S, 25 Liter
	530240	Purolite 25 Liter

Vorfilter für Wasserenthärter

Technische Daten:

Durchflussmenge: 1500Lit/h
 Betriebsdruck: 1 bis 8 bar
 Temperatur: 5 bis 20°C

Typ NL



Pos.	Best.-Nr.	G	L (mm)	Ø (mm)	Für Typ
1	530178	3/8"	58	59	MB, MM, MMV, AZB (8L), AZA (8L), AZV
2	530179	1/2"	58	59	

Typ NK



Abb.	Best.-Nr.	G	L (mm)	H (mm)	Für Typ
1	530182	3/8"	180	180,5	MB, MM, MMV, AZB (8L), AZA (8L), AZV
1	530183	1/2"	180	180,5	
2	530188	3/4"	180	306,5	AZA (12L, 20L), AZB (12L), AVA (12L, 20L), AZFW (12L, 20L)



Abb.	Best.-Nr.	Beschreibung
1	530186	Ersatzfilter (530182/ 530183)
2	530189	Ersatzfilter (530188)
3	530187	Schlüssel



Abb.	Bestell-Nr.	Beschreibung
1	530297	O-Ring
2	530292	Feder
3	530291	Buchse
4	530289	Stift
5	530281	Körper
6	530283	O-Ring
7	530280	Membrane
8	530295	Feder
9	530296	O-Ring
10	530279	Körper

Wasserhärte-Maßbesteck

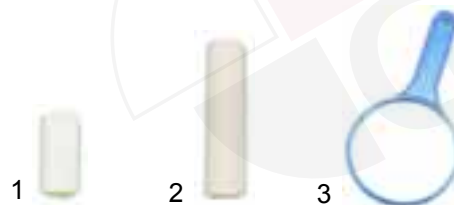

Pos.	Bestell-Nr.	Beschreibung
1	540620	Gesamthärte
2	540621	Karbonathärte

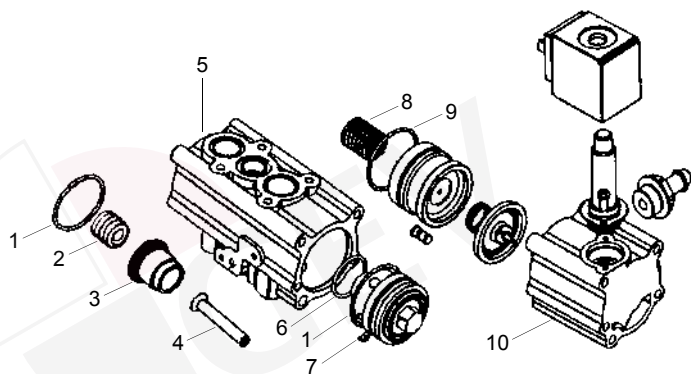
Entkarbonisierungssysteme

Everplus System

„Hartes Wasser“ verursacht regelmäßig Ausfälle und verkürzt die Lebensdauer von wassererhitzenden Maschinen. Durch das Erhitzen des Wassers entweicht Kohlensäure, so daß die Mineralien sich in Form von „Kalkablagerungen“ z. B. auf Ventilen, Heizelementen und Leitungen absetzen. Diese Kalkablagerungen führen unter bestimmtem Umständen zum Totalausfall.

Um die Probleme zu lösen und die Wirtschaftlichkeit Ihrer Maschinen zu erhöhen, bietet Everpure-Everplus ein einzigartiges Produkt, bestehend aus einem Harzbett und einem integrierten Aktivkohle-Blockfilter.

1. Das Harzbett.

Das schwach-saure Harz reduziert die Karbonathärte des Wassers. Der Kalkaufbau in den Maschinen wird somit verhindert.

Ein in jedem Ionenaustausch-Tank bereits eingebautes Verschneideventil stellt eine Genehmigung nach den lokalen Vorschriften sicher. Die Verschneidung kann von 20 - 50% beliebig vorgenommen werden.

2. Der Aktivkohle-Blockfilter

- ◆ entfernt jeglichen Fremdgeschmack und -geruch
- ◆ entfernt Partikel größer als 5 Mikron

Die Installation von einem Everpure-Anschwemmfilter mit Sub-Mikron-Filtration (0,5 Mikron), vor der Everplus-Anlage, wird sehr empfohlen. Dadurch werden Verunreinigungen wie Asbestfasern, Zysten und Mikroorganismen entfernt, so daß man den höchsten Ansprüchen an die Wasserqualität gerecht wird.

Die Everplus-Produkte sind in unterschiedlichen Größen verfügbar, um allen Erfordernissen (hohe Karbonathärte und/ oder hoher Wasserkonsum) entsprechen zu können.

Um die Nutzungszeit des Ionentauschers zu optimieren, ist es ratsam, eine Wasseruhr zu installieren, um den genauen Wasserverbrauch zu messen.

DEK-System (Bores) Neugeräte (ohne Anschlussstück)



Abb.	Bestell-Nr.	Typ	*Kapazität bei 15°KH	Maße in mm B x H
1	530332	DEK 8	5000 Liter	215 x 490
2	530333	DEK 15	9000 Liter	270 x 640

Tauschgeräte



Abb.	Bestell-Nr.	Typ	*Kapazität bei 15°KH	Maße in mm B x H
1	530336	DEKT 8	5000 Liter	215 x 490
2	530337	DEKT 15	9000 Liter	270 x 640

Anschlusskopf



Abb.	Bestell-Nr.	Typ
1	530334	kpl. mit mechanischer Wasseruhr
2	530335	kpl. mit elektronischer Wasseruhr



Abb.	Bestell-Nr.	Typ	*Kapazität bei 15°KH	Maße in mm BxTxH
1	530141	System 1	3105 Liter	275x180x625
2	530143	System 3	6800 Liter	350x250x625

Ersatzpatronen

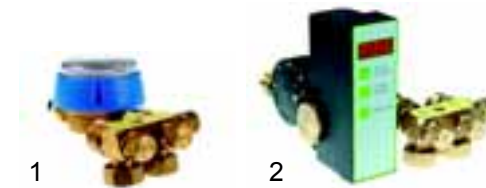
zu Abb.	Best.-Nr.	Typ	zu Abb.	Best.-Nr.	Typ
1	530148	System 1 neu	1	530149	System 1 regeneriert
2	530152	System 3 neu	2	530153	System 3 regeneriert

Kolonnen-Enthärter

2/3 Kolonnen



Abb. Nr.	Best.-Nr.	Maße in mm		
		L	B	H
1	530019	370	260	55
2	530021	430	240	40

4 Kolonnen



Abb. Nr.	Best.-Nr.	Maße in mm		
		L	B	H
1	530000	435	280	40
2	504046	435	290	40



Abb. Nr.	Best.-Nr.	Maße in mm		
		L	B	H
1	530001	435	260	40
2	505102	435	290	40



Pos.	Bestell-Nr.	Maße in mm		
		L	B	H
1	518233	410	220	40

6 Kolonnen



Abb. Nr.	Best.-Nr.	Maße in mm		
		L	B	H
1	518545	430	340	40
2	518296	410	290	40

8 Kolonnen



Abb. Nr.	Best.-Nr.	Maße in mm		
		L	B	H
1	501170	400	440	40
2	530006	430	445	40

Salzbehälter

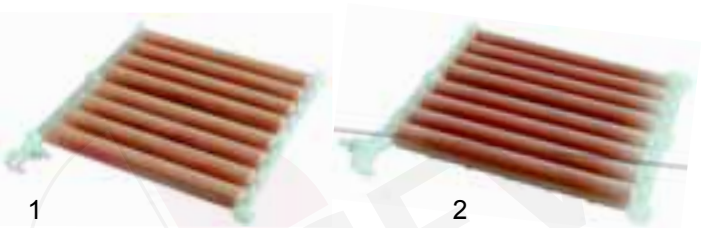

Abb. Nr.	Best.-Nr.	Maße in mm			
		D	G1	G2	H
1	510032	90	54	68	110
2	511894	125	54	68	115
3	510924	125	54	68	115

Wasser-Armaturen mit 1/2" Oberteil

Strahlregler, verchromt

Schwenkventil mit S-Auslauf

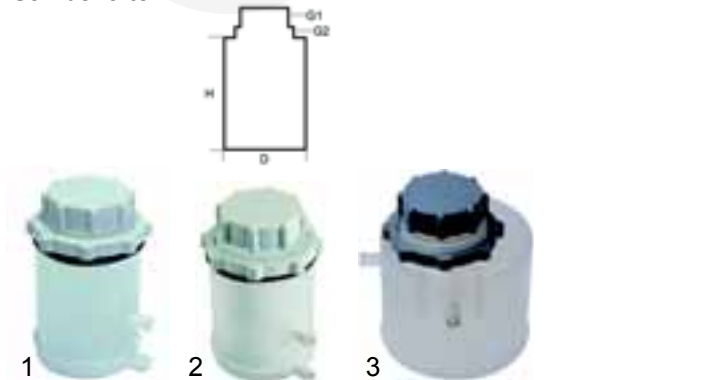

Mit Standard-Oberteil			Mit Keramik-Oberteil		
Pos.	Bestell-Nr.	Maße in mm	Pos.	Bestell-Nr.	Maße in mm
		A H			A H
1	540176	200 120	4	540380	200 120
2	540177	250 120	5	540381	250 120
3	540178	300 120	6	540382	300 120

Standschwenkventil mit HU-Auslauf

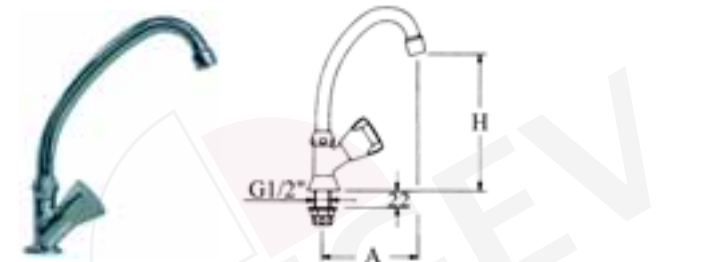

Mit Standard-Oberteil			Mit Standard-Oberteil		
Pos.	Bestell-Nr.	Maße in mm	Pos.	Bestell-Nr.	Maße in mm
		A H			A H
1	540332	155 195	2	540333	200 250

2

Universalteile/ Mechanik

Einlochmischbatterie mit HU-Auslauf



Mit Standard-Oberteil			
Abb.	Bestell-Nr.	Maße in mm	
		A	H
1	540339	155	190
1	540168	200	245
1	540334	250	255
2	540346	200	170
2	540347	250	200

Mit Keramik-Oberteil			
Abb.	Bestell-Nr.	Maße in mm	
		A	H
2	540348	300	230
2	540383	200	170
2	540384	250	200
2	540385	300	230

Standbatterie verstellbar mit HU-Auslauf



Mit Standard-Oberteil			
Pos.	Bestell-Nr.	Maße in mm	
		A	H
1	540330	200	230
2	540331	250	270
3	540335	300	290

Mit Keramik-Oberteil			
Pos.	Bestell-Nr.	Maße in mm	
		A	H
4	540395	200	230
5	540396	250	270
6	540397	300	290

Spültisch-Batterie mit S-Auslauf

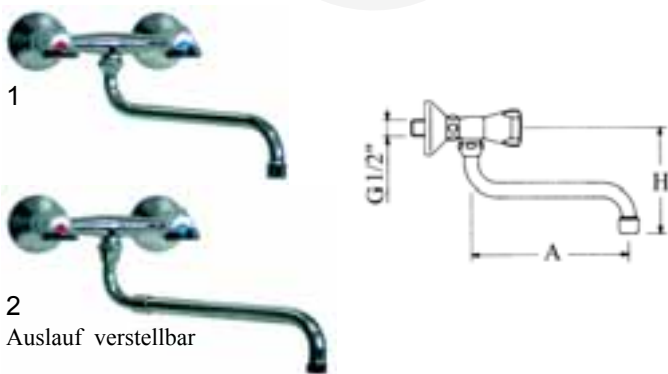

Mit Standard-Oberteil			
Abb.	Bestell-Nr.	Maße in mm	
		A	H
1	540173	200	120
1	540174	250	120
1	540175	300	120
2	540336	200-300	120
2	540337	280-480	120
2	540338	350-600	120

Mit Keramik-Oberteil			
Abb.	Bestell-Nr.	Maße in mm	
		A	H
1	540389	200	120
1	540390	250	120
1	540391	300	120
2	540392	200-300	120
2	540393	280-480	120
2	540394	350-600	120

HU-Ausläufe 3/4" Überwurfmutter



Abb.	Bestell-Nr.	Maße in mm	
		A	H
1	540033	155	125
1	540034	200	180
1	540035	250	190

Abb.	Bestell-Nr.	Maße in mm	
		A	H
2	540191	200	130
2	540192	250	160
2	540193	300	190

U + S-Ausläufe mit 3/4" Überwurfmutter



Abb.	Bestell-Nr.	Maße in mm	
		A	H
1	540027	200	75
1	540028	250	75
1	540029	300	75
2	540030	200	120
2	540031	250	120

Abb.	Bestell-Nr.	Maße in mm	
		A	H
2	540086	300	120
3	540084	200-300	120
3	540032	280-480	120
3	540085	350-600	120

Oberteil Kpl. mit Griff, blauer und roter Farbkappe

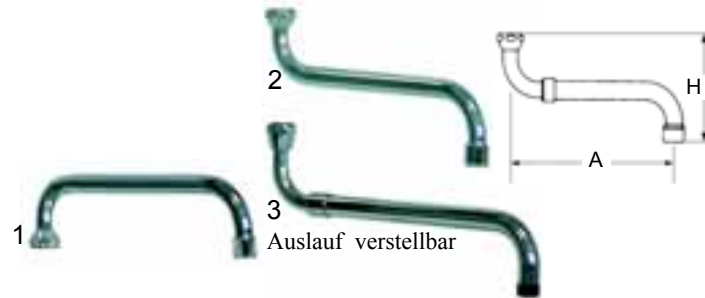

Abb.	Best.-Nr.	Maße in mm		
		L	G	D
1	540018	18-23	1/2"	16

Abb.	Best.-Nr.	Maße in mm
2	510391	Dichtung 16x4x4

3-Kant-Haubengriff mit blauer und roter Kappe



Abb.	Bestell-Nr.
1	540447

Abb.	Bestell-Nr.
2	540359

Wasser-Armaturen (schwere Ausführung) mit Long-Life-Oberteil 1/2" Strahlregler, verchromt

Einloch-Mischbatterie mit HU-Auslauf



Pos.	Bestell-Nr.	Maße in mm		Pos.	Bestell-Nr.	Maße in mm	
		A	H			A	H
1	540151	250	205	2	540152	350	285

Ausläufe + Oberteile



Abb.	Bestell-Nr.	Maße in mm		Abb.	Bestell-Nr.	Beschreibung
		A	H			
1	540418	250	170	3	540412	Griff
1	540419	350	250	4	540328	Kappe blau
2	540411	Oberteil 1/2"		5	540420	Kappe rot

Wasser-Armaturen m. Friaul-Oberteil 1/2" Strahlregler, verchromt

Standbatterie 1/2"

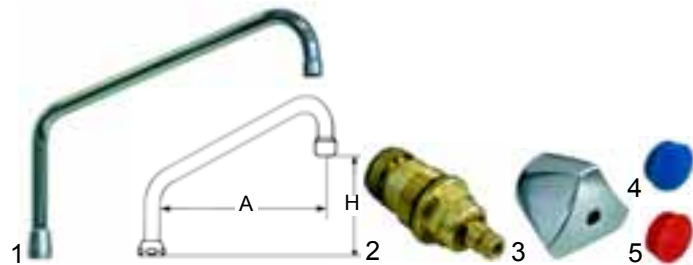

Pos.	Bestell-Nr.	Maße in mm			Pos.	Bestell-Nr.	Maße in mm		
		A	H	G			A	H	G
1	540179	200	210	1/2"	4	540182	200	210	3/4"
2	540180	250	240	1/2"	5	540183	250	240	3/4"
3	540181	300	270	1/2"	6	540184	300	270	3/4"

Ausläufe + Oberteile



Abb.	Bestell-Nr.	Maße in mm		Abb.	Bestell-Nr.	Beschreibung
		A	H			
1	540191	200	130	2	540286	Oberteil 21x19
1	540192	250	160	3	540316	Griff rot
1	540193	300	190	3	540317	Griff blau

Wasser-Armaturen 3/4"-Oberteil Strahlregler, verchromt

Einloch-Mischbatterie Friaul-Oberteil 3/4" mit HU-Auslauf

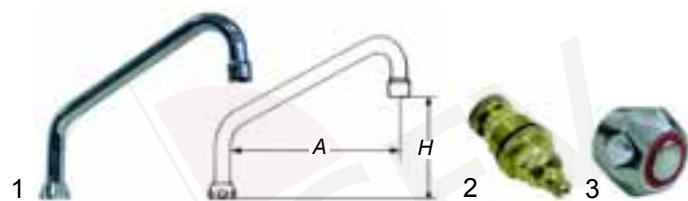

Abb.	Bestell-Nr.	Maße in mm		Abb.	Bestell-Nr.	Maße in mm	
		A	H			A	H
1	540092	300	260	2	540094	-	325
1	540093	400	310				

Ausläufe + Oberteile

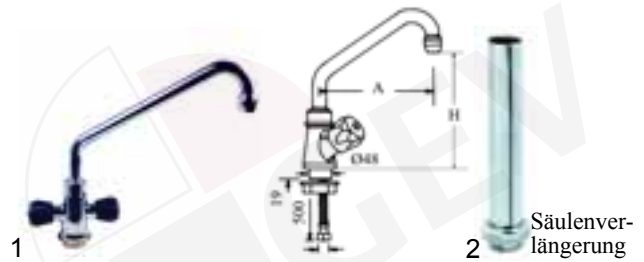

Abb.	Bestell-Nr.	Maße/mm		Abb.	Bestell-Nr.	Beschreibung
		A	H			
1	540318	300	260	2	540413	Oberteil 3/4"
1	540319	400	310	3	540414	Griff rot
				3	540415	Griff blau

Wasser-Armaturen 3/4"-Oberteil Made in Germany

Spültischbatterie, Ventilsatz Edelstahl, Kunststoffhaubengriff ohne Montagestützen

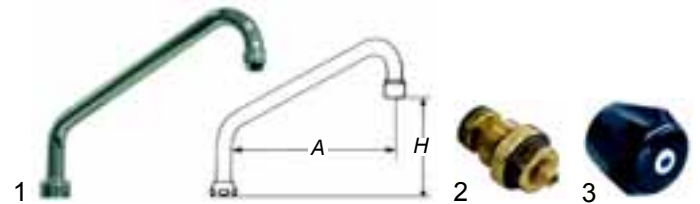
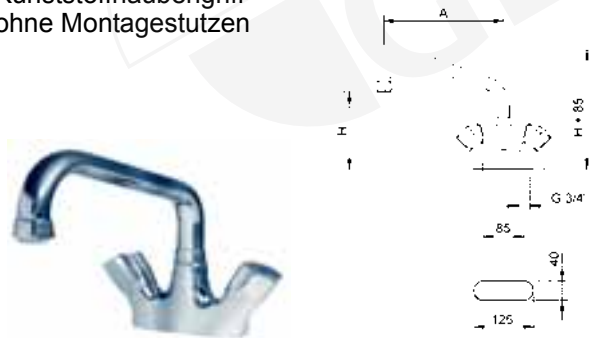

Pos.	Bestell-Nr.	Maße/mm		Pos.	Bestell-Nr.	Maße/mm	
		A	H			A	H
1	540019	250	150	2	540195	350	150
3	540329	300	150	4	540169	400	150

Montagestützen 3/4" kpl. mit Mutter und Dichtungen

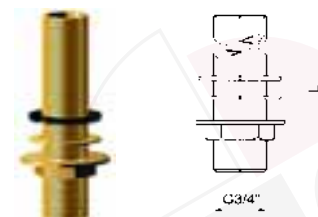

Pos.	Bestell-Nr.	Maße/mm		Pos.	Bestell-Nr.	Maße/mm	
		L				L	
1	540326	115		2	540327	200	

Einlochmischbatterie 1 1/4"

Cu-Rohr 15mm, Kunststoffhaubengriff

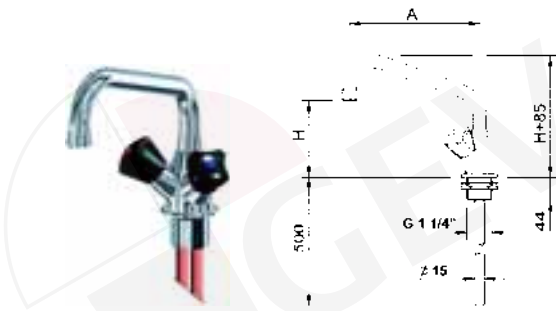

Pos.	Bestell-Nr.	Maße/mm	Pos.	Bestell-Nr.	Maße/mm
		A H			A H
1	540217	250 1400	3	540257	400 140
2	540252	300 140	4	540258	300 230

Einlochmischbatterie 1 1/2"

Cu-Rohr 15mm, Kunststoffhaubengriff

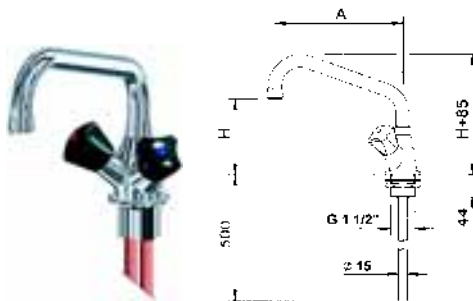

Pos.	Bestell-Nr.	Maße/mm	Pos.	Bestell-Nr.	Maße/mm
		A H			A H
1	540287	250 140	3	540303	400 140
2	540299	300 140	4	540307	300 230

Einlochmischbatterie 1 1/4" auf Säule

Cu-Rohr 15mm, Kunststoffhaubengriff

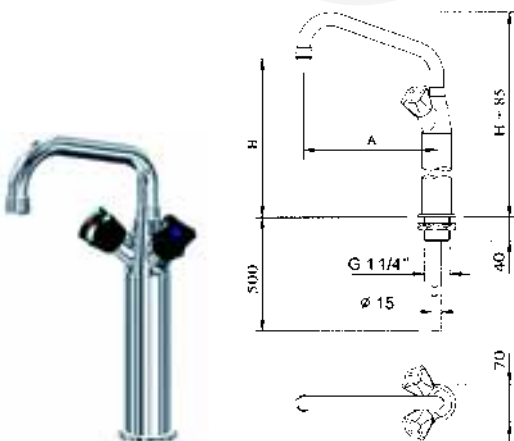

Pos.	Bestell-Nr.	Maße/mm	Pos.	Bestell-Nr.	Maße/mm
		A H			A H
1	540315	300 400	5	540398	500 400
2	540374	300 500	6	540399	500 500
3	540375	400 400	7	540407	400-600 440
4	540376	400 500			

Einlochmischbatterie 1 1/2" auf Säule

Cu-Rohr 15mm, Kunststoffhaubengriff

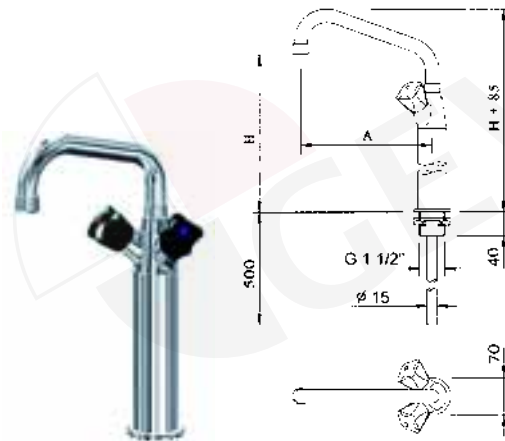

Pos.	Bestell-Nr.	Maße/mm	Pos.	Bestell-Nr.	Maße/mm
		A H			A H
1	540408	300 400	5	540449	500 400
2	540409	300 500	6	540458	500 500
3	540427	400 400	7	540459	400-600 440
4	540445	400 500			

Spültischbatterie

Ventilsitz (Edelstahl), Kunststoffhaubengriff

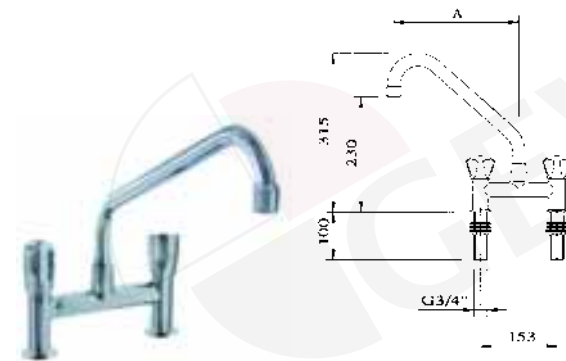

Pos.	Bestell-Nr.	Maße/mm	Pos.	Bestell-Nr.	Maße/mm
		A			A
1	540502	300	3	540504	400
2	540503	350			

Wandbatterie mit Kunststoffhaubengriff

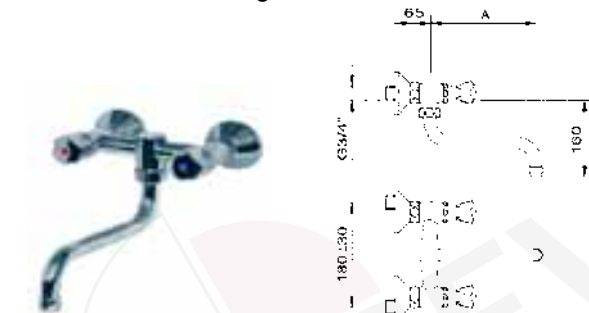

Pos.	Bestell-Nr.	Maße/mm	Pos.	Bestell-Nr.	Maße/mm
		A			A
1	540505	200	3	540507	300
2	540506	250	4	540508	400

Schwenkventil
Ventilsitz (Edelstahl), Kunststoffhaubengriff,
ohne Montagestutzen



für Kaltwasser für Warmwasser

Für Kaltwasser				Für Warmwasser			
Pos.	Bestell-Nr.	Maße/mm		Pos.	Bestell-Nr.	Maße/mm	
		A	H			A	H
1	540509	250	150	4	540528	250	150
2	540526	400	150	5	540529	400	150
3	540527	300	240	6	540533	300	240

Montagestutzen 3/4"
kpl. mit Mutter und Dichtung

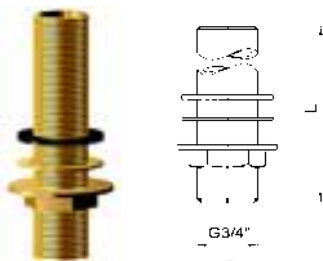

Pos.	Bestell-Nr.	Maße/mm	Pos.	Bestell-Nr.	Maße/mm
		L			L
1	540326	115	2	540327	200

Schwenkventil auf Säule,
Ventilsitz (Edelstahl), Kunststoffhaubengriff



Für Kaltwasser Für Warmwasser

Für Kaltwasser				Für Warmwasser			
Pos.	Bestell-Nr.	Maße/mm		Pos.	Bestell-Nr.	Maße/mm	
		A	H			A	H
1	540534	250	400	4	540540	250	400
2	540538	400	400	5	540541	400	400
3	540539	400-600	440	6	540542	400-600	440

Einlochmischbatterie
Fettkammeroberteile, Dreikanthaubengriffe
mit Stutzen M52 x 1,5 x 43



Pos.	Bestell-Nr.	Maße/mm	Pos.	Bestell-Nr.	Maße/mm
		A			A
1	540466	250	3	540469	400
2	540467	300			

Einlochmischbatterie auf Säule
Fettkammeroberteile, Dreikanthaubengriffe, mit Stutzen
M52 x 1,5 x 43, mit Restwasserentleerung

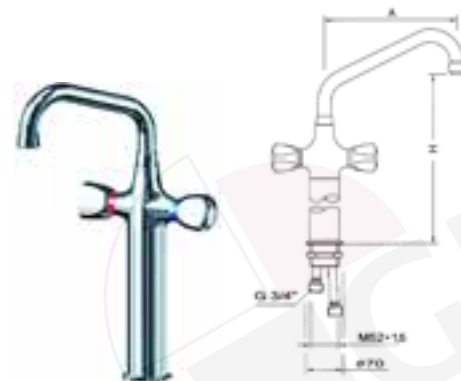

Pos.	Bestell-Nr.	Maße/mm	Pos.	Bestell-Nr.	Maße/mm
		A			A
1	540482	250	3	540500	400
2	540492	300	4	540501	500

Ausläufe für 3/4" Armaturen,
U-Auslauf mit Kunststoffstrahlregler M28 x 1



Pos.	Bestell-Nr.	Maße/mm	Pos.	Bestell-Nr.	Maße/mm
		A			A
1	540592	250	4	540595	400
2	540593	300	5	540596	450
3	540594	350	6	540597	500

HU-Auslauf hoch mit Kunststoffstrahlregler M28 x 1

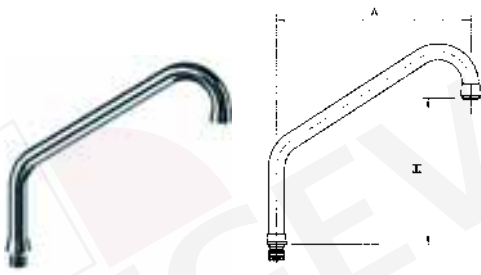

Pos.	Bestell-Nr.	Maße/mm		Pos.	Bestell-Nr.	Maße/mm	
		A	H			A	H
1	540598	250	150	8	540611	350	150
2	540599	250	210	9	540612	350	210
3	540607	250	310	10	540613	350	310
4	540608	300	150	11	540614	400	150
5	540609	300	210	12	540615	400	210
6	540610	300	310	13	540616	400	310

HU-Auslauf hoch mit Restwasserentleerung



Pos.	Bestell-Nr.	Maße/mm		Pos.	Bestell-Nr.	Maße/mm	
		A				A	
1	540617	250		3	540619	400	
2	540618	300		4	540622	500	

S-Auslauf mit Überwurfmutter 1"



Pos.	Bestell-Nr.	Maße/mm		Pos.	Bestell-Nr.	Maße/mm	
		A				A	
1	540623	200		3	540626	300	
2	540624	250		4	540627	450	

Adapter

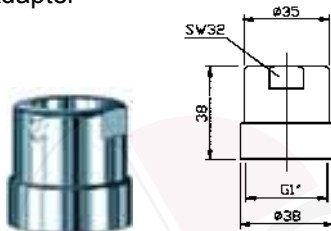

Pos.	Bestell-Nr.	Beschreibung
1	540589	Zum Einsatz der U-Ausläufe in Wandbatterien mit 1" Außengewinde

Gelenkstück

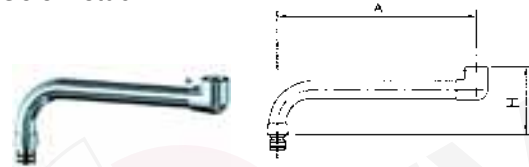

Pos.	Bestell-Nr.	Maße/mm		Pos.	Bestell-Nr.	Maße/mm	
		A				A	
1	540628	300		2	540629	500	

U-Auslauf, ausziehbar mit Wasserstrahlregler M28 x 1



Pos.	Bestell-Nr.	Maße/mm	
		A	
1	540630	400 - 600	



Abb.	Bestell-Nr.	Beschreibung
1	540312	Oberteil 3/4", Standard
2	540591	Oberteil 3/4", Kerramik



Abb.	Bestell-Nr.	Beschreibung
1	540313	Griff blau
2	540314	Griff rot



Abb.	Bestell-Nr.	Beschreibung
1	540574	Oberteil 3/4", Dreisterngriff rot
2	540575	Oberteil 3/4", Dreisterngriff blau



Pos.	Bestell-Nr.	Beschreibung
1	540631	Fettkammeroberteil 3/4"

Wasser-Armaturen-Einhebelmischer Strahlregler, verchromt

Einloch-Waschtischbatterie mit festem Auslauf

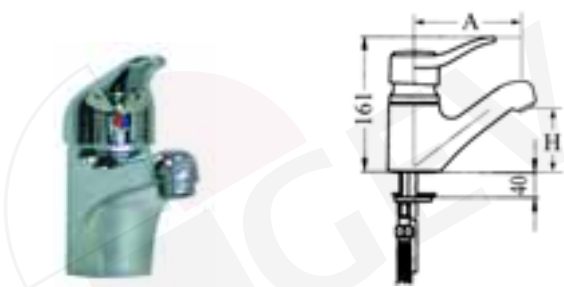

Pos.	Bestell-Nr.	A /mm	H/mm
1	540167	120	50

Einloch-Spültischbatterie mit ausziehbarer Handbrause und Schwenkauslauf



Abb.	Best.-Nr.	A	H
1	540161	210mm	110mm
2	540162	210mm	110mm

2 Einlochmischbatterie mit Schwenkauslauf



Pos.	Bestell-Nr.	Maße in mm		Pos.	Bestell-Nr.	Maße in mm	
		A	H			A	H
1	540377	200	230	3	540379	300	290
2	540378	250	260				

Ersatzteile



Abb.	Best.-Nr.	Beschreibung	L
1	540452	Kartusche	
2	540453	Hebel kurz	120



Abb.	Best.-Nr.	Maße in mm		Abb.	Best.-Nr.	Maße/mm		
		A	H			A	L	B
1	540191	200	130	2	540450	40	80	10x10
1	540192	250	160	3	540451	-	120	10x10
1	540193	300	190					

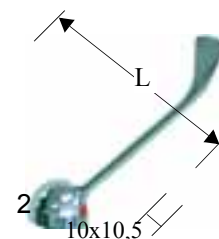

1 Schlauch

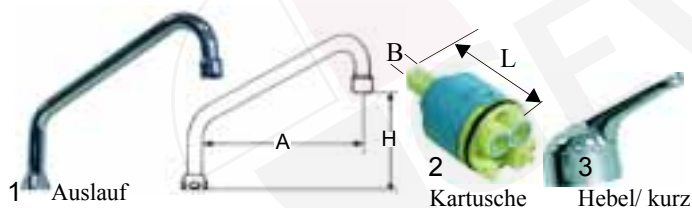

2 Handbrause

Abb.	Bestell-Nr.	G
1	540455	1/2"
2	540456	1/2"

Einloch-Spültischbatterie mit Schwenkauslauf



Abb.	Best.-Nr.	A	H
1	540159	230mm	125mm
2	540160	230mm	135mm

Wasser-Armaturen Strahlregler, verchromt

Stand-Spültischbatterie mit Langhebel und Schwenkauslauf

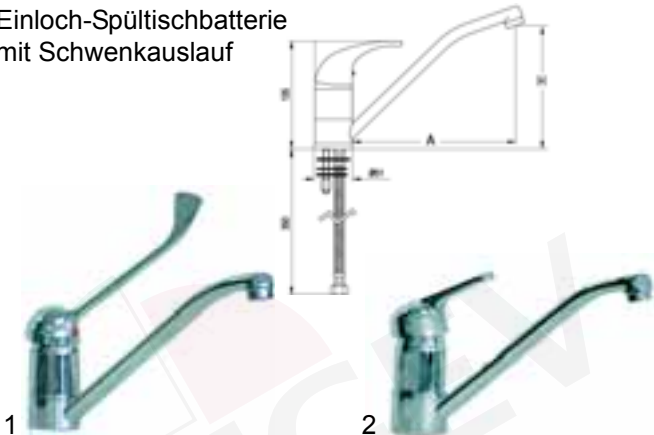

Pos.	Best.-Nr.	Maße/mm		
		A	H	G
1	540163	200	235	1/2"
2	540164	300	235	1/2"

Ersatzteile



Abb. Nr.	Bestell-Nr.	Maße in mm		Abb. Nr.	Bestell-Nr.	Maße in mm	
		A	H			A	H
1	540196	200	150	3	540288	-	-
2	540203						

Wasser-Armaturen Strahlregler, verchromt

Wand-Spültischbatterie mit Langhebel und Schwenkauslauf

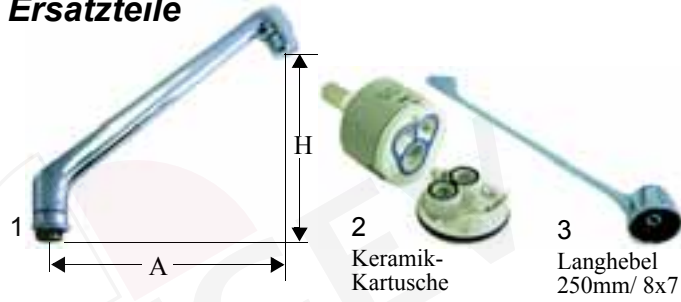
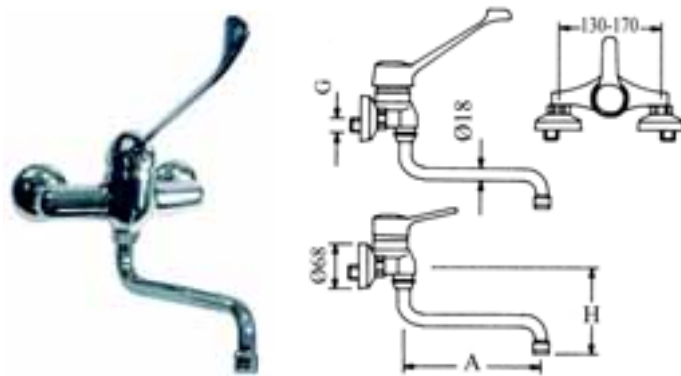

Pos.	Best.-Nr.	Maße/mm			Pos.	Best.-Nr.	Maße/mm		
		A	H	G			A	H	G
1	540165	200	145	1/2"	2	540166	300	150	1/2"

Ersatzteile



Abb. Nr.	Bestell-Nr.	Maße in mm		Abb. Nr.	Bestell-Nr.	Maße in mm	
		A	H			A	H
1	540030	200	120	2	540204	-	-
1	540031	250	120	3	540668	-	-
1	540086	300	120	4	540289	-	-

Dichtungen für Hahnoberteil



Abb. Nr.	Bestell-Nr.	VPE	Größe	Abmessungen/mm
				D1 x D2 x H
1	510390	10	3/8"	13x4x4,5
1	510391	10	1/2"	17x4x4,5
1	510392	10	3/4"	23x4x4,5
2	510395	10	3/8"	15x4,8x4,5
2	510396	1	1/2"	17x5x4,5
2	510397	1	3/4"	23x6x5

Elektronische Wasserarmaturen/Billo

Mit Hebelmischer, Typ MIX



Pos.	Best.-Nr.	Beschreibung	Versorgung
1	540716	kpl. mit Eckventil, Trafo und Schläuchen	230V AC

Ohne Hebelmischer, Typ TAP



Pos.	Best.-Nr.	Beschreibung	Versorgung
1	540717	kpl. mit Eckventil, Trafo und Schläuchen	230V AC

Ersatzteile



Abb. Nr.	Best.-Nr.	Beschreibung	Typ
1	540718	Elektronik kpl. mit Sensor	TAP
2	540719	Elektronik kpl. mit Sensor	MIX



Abb. Nr.	Best.-Nr.	Beschreibung	Typ
1	540723	Magnetventil, 12V DC	TAP, MIX
2	540724	Magnetspule, 12V DC	TAP, MIX



Abb. Nr.	Best.-Nr.	Beschreibung	Typ
1	540725	Transformator, 230V AC/12V DC	TAP, MIX
2	540726	Schlauch, 380mm (Länge)	TAP, MIX

Elektronische Wasserarmaturen, berührungslos, Metallguss, glanzverchromt

Mit Hebelmischer

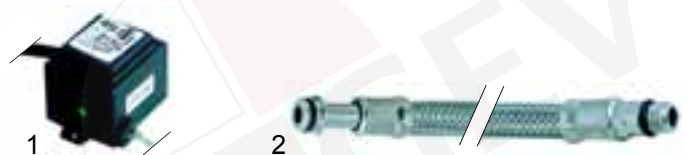

Technische Daten:

Betriebsdruck: 6 bar
Wasseranschluss: kalt und warm
Wassertemperatur: 60°C

Pos.	Best.-Nr.	Versorgung	Pos.	Best.-Nr.	Versorgung
1	540790	220V/50Hz	2	540791	4,5V (3x1,5)

Ohne Hebelmischer



Technische Daten:

Betriebsdruck: 6 bar
Wasseranschluss: kalt, warm oder vorgemischt
Wassertemperatur: 60°C
Batterielebensdauer: ca 2-3 Jahre

Pos.	Best.-Nr.	Versorgung	Pos.	Best.-Nr.	Versorgung
1	540792	220V/50Hz	2	540793	4,5V (3x1,5)

Für 230V- und Batterieversion

Abb.	Bestell-Nr.	Beschreibung
1	540800	Deckeldichtung
6	540805	Strahlregler
7	540806	Mixer
8	540807	Mixhebel
9	540809	Dichtung
10	540810	CNS-Schlauch
11	540808	Rücksaugverhinderer mit Schmutzsiebträger
12	540811	Schmutzsieb

Für 230V-Version

3	540813	Sensor kpl. mit Elektronik 230V
4	540814	Magnetventil kpl. Monostabil 12V/DC
5	540815	Magnetspule Monostabil 12V/DC
13	540812	Transformator 230V/14VAC

Für Batterieversion

2	540801	Batteriekasten
3	540802	Sensor kpl. mit Elektronik-Batterie
4	540803	Magnetventil kpl. Bistabil 3VDC
5	540804	Magnetspule 3VDC

Ersatzteile Elektronik-Armaturen

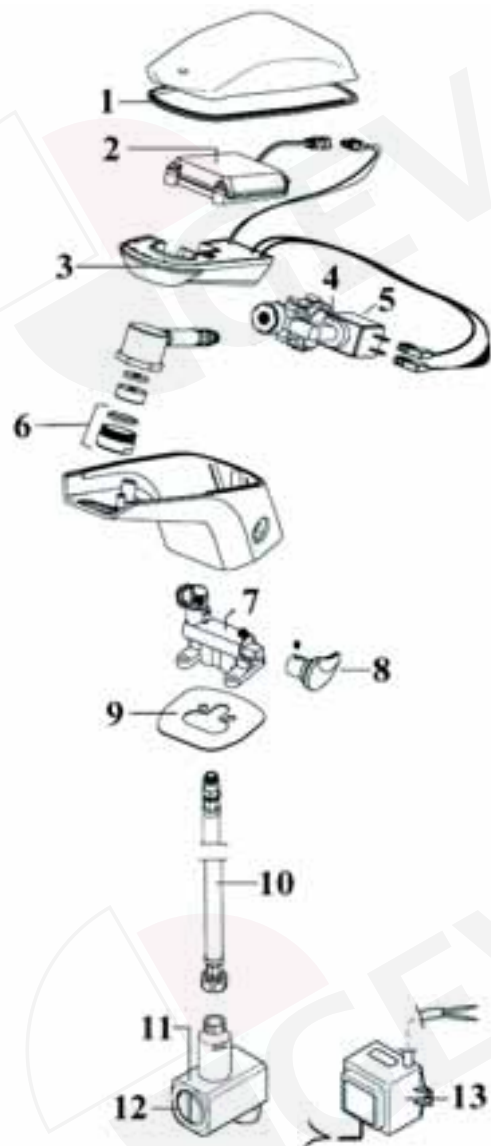

Berührungsfreie Bedienung gemäß LMHVO und HACCP

Seit 1. März 1999 gilt für alle Betriebe, die Lebensmittel verarbeiten, die neue Lebensmittelhygiene-Verordnung (LMHVO) und deren Umsetzung in die Praxis nach den HACCP-Richtlinien. Für eine hygienisch sichere Arbeitsweise wird deshalb von den Kontrollbehörden für Handwaschbecken in Küche und WC die „berührungsfreie Bedienung“ von Armaturen vorausgesetzt.

Thermostat

Technische Daten:

Betriebsdruck: max 10bar
Temperaturbereich: 30° bis 70°C
Wasser-Eingangs-Temperatur: max 95°C
Temperatur-Stellungen:

Stellg.	Min.	1	2	3	4	5	Max.
°C	27	30	35	40	50	60	70

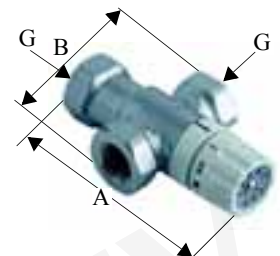

Pos.	Bestell-Nr.	A/mm	B/mm	G
1	540269	116	54	1/2"

Wasser-Armaturen (Spülwannen)

Einlochmischbatterie für 1 Waschbecken
mit 1 Unterspülrohr



Technische Daten:

Standard-Oberteil 3/8"
3-Kant-Haubengriffe
(Made in Germany)
Schwenkauslauf mit
Strahlregler, verchromt
CNS - Anschlussleitung
500mm lang
Hochdruck 2-6 bar für Netz-Betrieb
Niederdruck für Boiler-Betrieb
Unterspülrohr, verchromt

Pos.	Bestell-Nr.	Anschluss-Schlauch/ Druck
1	540270	2 / Hochdruck 2-6 bar
2	540271	3/ Niederdruck

Einlochmischbatterie für 2 Waschbecken
mit 2 Unterspülrohren



Technische Daten:

Standard-Oberteil 3/8"
3-Kant-Haubengriffe
(Made in Germany)
Schwenkauslauf mit
Strahlregler, verchromt
CNS - Anschlussleitung
500mm lang
Hochdruck 2-6 bar für Netz-Betrieb
Niederdruck für Boiler-Betrieb
Unterspülrohr, verchromt

Pos.	Bestell-Nr.	Anschluss-Schlauch/ Druck
1	540272	2/ Hochdruck 2-6 bar
2	540273	3/ Niederdruck

Ausläufe
und Oberteile



Abb. Nr.	Best.-Nr.	Beschreibung	Abb. Nr.	Best.-Nr.	Maße/mm A H
1	540017	Hahnoberteil 3/8" kpl. 3-Kant-Haubengriff m. rot/blauer Kappe	3	540027	200 75
2	540274	Unterspülrohr			

Geschirrabrasen mit Standardoberteilen 1/2"

Oberteil:

- DIN-Norm made in Germany
- Bei Mischbatterie mit Rückschlagventilen

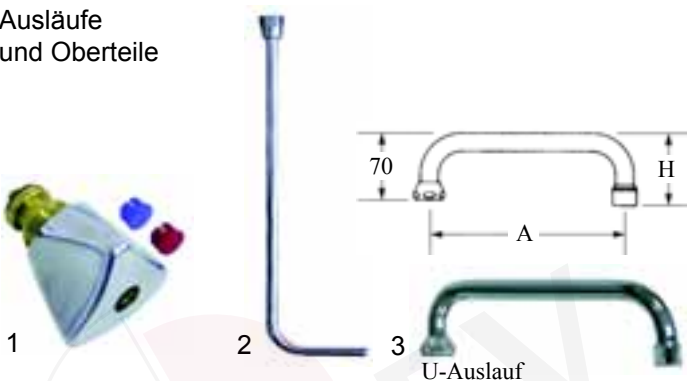
Schlauch:

- CNS-Wellenschlauch mit KTW-Freigabe und DVGW-Zulassung
- Temperaturbeständig bis 90°C

Rückflussverhinderer:

- Nicht nötig, da Rückschlagventile

Handbrausen



Kzf.	Best.-Nr.	Typ	Kzf.	Best.-Nr.	Typ
0	540005	Exklusiv	2	540004	Robust
1	540150	Standard	3	540089	Economy

Steigrohr kpl.

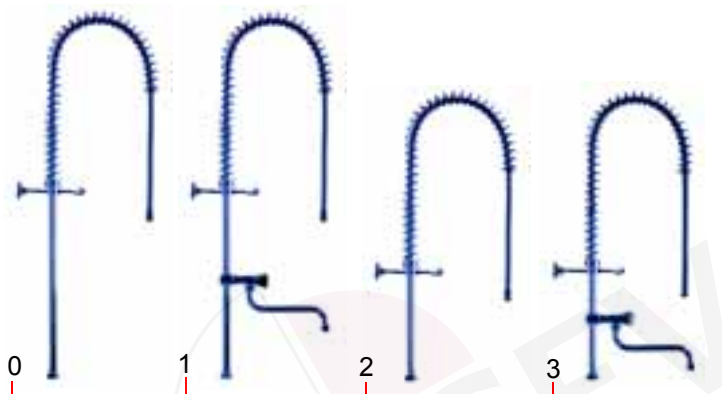

Kzf.	Best.-Nr.	Beschreibung	Kzf.	Best.-Nr.	Beschreibung
0	540566	lang	2	540568	kurz
1	540565	lang mit Schwenkventil	3	540567	kurz mit Schwenkventil

Unterteile



Kzf.	B.-Nr.	Beschreibung	Kzf.	B.-Nr.	Beschreibung
0	540022	Standventile	2	540026	Standmischbatterie
1	540087	Mischbatterie	5	540088	Wandmischbatterie



Kzf.	B.-Nr.	Beschreibung	Kzf.	B.-Nr.	Beschreibung
6	540341	Wandmischbatterie mit Umstellung	8	540491	Standmischbatterie mit Umstellung
7	540490	Standmischbatterie			



Best.-Nr.	Geschirrbt.kpl.	bestehend aus einzelnen Teilen		
		Unterteile	Steigrohr	Handbrause
5 4 3 0 0 0		540022	540566	540005
5 4 3 0 0 1		540022	540566	540150
5 4 3 0 0 2		540022	540566	540004
5 4 3 0 0 3		540022	540566	540089
5 4 3 0 1 0		540022	540565	540005
5 4 3 0 1 1		540022	540565	540150
5 4 3 0 1 2		540022	540565	540004
5 4 3 0 1 3		540022	540565	540089
5 4 3 1 0 0		540087	540566	540005
5 4 3 1 0 1		540087	540566	540150
5 4 3 1 0 2		540087	540566	540004
5 4 3 1 0 3		540087	540566	540089
5 4 3 1 1 0		540087	540565	540005
5 4 3 1 1 1		540087	540565	540150
5 4 3 1 1 2		540087	540565	540004
5 4 3 1 1 3		540087	540565	540089
5 4 3 2 0 0		540026	540566	540005
5 4 3 2 0 1		540026	540566	540150
5 4 3 2 0 2		540026	540566	540004
5 4 3 2 0 3		540026	540566	540089
5 4 3 2 1 0		540026	540565	540005
5 4 3 2 1 1		540026	540565	540150
5 4 3 2 1 2		540026	540565	540004
5 4 3 2 1 3		540026	540565	540089
5 4 3 5 2 0		540088	540568	540005
5 4 3 5 2 1		540088	540568	540150
5 4 3 5 2 2		540088	540568	540004
5 4 3 5 2 3		540088	540568	540089
5 4 3 5 3 0		540088	540567	540005
5 4 3 5 3 1		540088	540567	540150
5 4 3 5 3 2		540088	540567	540004
5 4 3 5 3 3		540088	540567	540089
5 4 3 6 2 0		540341	540568	540005
5 4 3 6 2 1		540341	540568	540150
5 4 3 6 2 2		540341	540568	540004
5 4 3 6 2 3		540341	540568	540089
5 4 3 7 2 0		540490	540568	540005
5 4 3 7 2 1		540490	540568	540150
5 4 3 7 2 2		540490	540568	540004
5 4 3 7 2 3		540490	540568	540089
5 4 3 7 3 0		540490	540567	540005
5 4 3 7 3 1		540490	540567	540150
5 4 3 7 3 2		540490	540567	540004
5 4 3 7 3 3		540490	540567	540089
5 4 3 8 2 0		540491	540568	540005
5 4 3 8 2 1		540491	540568	540150
5 4 3 8 2 2		540491	540568	540004
5 4 3 8 2 3		540491	540568	540089

2
Universalteile/ Mechanik

Geschirrbrausen mit Keramikoberteilen 1/2"

Oberteil:

- DIN-Norm made in Germany
- Mit Keramiksitz

Schlauch:

- CNS-Wellenschlauch mit KTW-Freigabe und DVGW-Zulassung
- Temperaturbeständig bis 90°C

Rückflussverhinderer:

- Für Wasserzulauf im Lieferumfang (DVGW-Zulassung)



Handbrausen



Kzf.	Best.-Nr.	Typ	Kzf.	Best.-Nr.	Typ
0	540005	Exklusiv	2	540004	Robust
1	540150	Standard	3	540089	Economy

Steigrohr kpl.

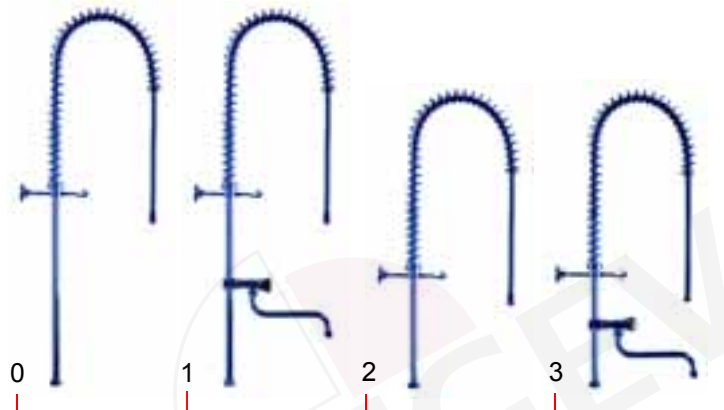

Kzf.	Best.-Nr.	Beschreibung	Kzf.	Best.-Nr.	Beschreibung
0	540566	lang	2	540568	kurz
1	540564	lang mit Schwenkventil	3	540563	kurz mit Schwenkventil

Unterteile



Kzf.	Best.-Nr.	Beschreibung	Kzf.	Best.-Nr.	Beschreibung
0	540448	Standventile	2	540353	Standmischbatterie
1	540352	Mischbatterie	5	540354	Wandmischbatterie



Kzf.	Best.-Nr.	Beschreibung	Kzf.	Best.-Nr.	Beschreibung
6	540357	Wandmischbatterie mit Umstellung	8	540497	Standmischbatterie mit Umstellung
7	540496	Standmischbatterie			

Best.-Nr.	bestehend aus einzelnen Teilen		
Geschirrbraus.kpl.	Unterteile	Steigrohr	Handbrause
540488		540566	540005
540488		540566	540150
540488		540566	540004
540488		540566	540089
544010	540488	540564	540005
544011	540488	540564	540150
544012	540488	540564	540004
544013	540488	540564	540089
544100	540352	540566	540005
544101	540352	540566	540150
544102	540352	540566	540004
544103	540352	540566	540089
544110	540352	540564	540005
544111	540352	540564	540150
544112	540352	540564	540004
544113	540352	540564	540089
544200	540353	540566	540005
544201	540353	540566	540150
544202	540353	540566	540004
544203	540353	540566	540089
544210	540353	540564	540005
544211	540353	540564	540150
544212	540353	540564	540004
544213	540353	540564	540089
544520	540354	540568	540005
544521	540354	540568	540150
544522	540354	540568	540004
544523	540354	540568	540089
544530	540354	540563	540005
544531	540354	540563	540150
544532	540354	540563	540004
544533	540354	540563	540089
544620	540357	540568	540005
544621	540357	540568	540150
544622	540357	540568	540004
544623	540357	540568	540089
544720	540496	540568	540005
544721	540496	540568	540150
544722	540496	540568	540004
544723	540496	540568	540089
544730	540496	540563	540005
544731	540496	540563	540150
544732	540496	540563	540004
544733	540496	540563	540089
544820	540497	540568	540005
544821	540497	540568	540150
544822	540497	540568	540004
544823	540497	540568	540089

Geschirrbräusen mit Einhebelmischer 1/2"

Oberteil:

-Mit Keramikkartuschen

Schlauch:

-CNS-Wellenschlauch mit KTW-Freigabe und DVGW-Zulassung

-Temperaturbeständig bis 90°C

Rückflussverhinderer:

-Für Wasserzulauf im Lieferumfang (DVGW-Zulassung)



Handbräusen

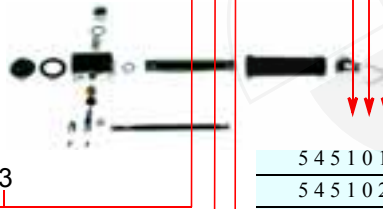

bestehend aus einzelnen Teilen

kpl.	Unterteile	Steigrohr	Handbrause
	540351	540566	540005
5 4 5 1 0 1	540351	540566	540150
5 4 5 1 0 2	540351	540566	540004
5 4 5 1 0 3	540351	540566	540089
5 4 5 1 1 0	540351	540564	540005
5 4 5 1 1 1	540351	540564	540150
5 4 5 1 1 2	540351	540564	540004
5 4 5 1 1 3	540351	540564	540089
5 4 5 3 0 0	540186	540566	540005
5 4 5 3 0 1	540186	540566	540150
5 4 5 3 0 2	540186	540566	540004
5 4 5 3 0 3	540186	540566	540089
5 4 5 4 0 0	540187	540566	540005
5 4 5 4 0 1	540187	540566	540150
5 4 5 4 0 2	540187	540566	540004
5 4 5 4 0 3	540187	540566	540089
5 4 5 5 2 0	540188	540568	540005
5 4 5 5 2 1	540188	540568	540150
5 4 5 5 2 2	540188	540568	540004
5 4 5 5 2 3	540188	540568	540089
5 4 5 5 3 0	540188	540563	540005
5 4 5 5 3 1	540188	540563	540150
5 4 5 5 3 2	540188	540563	540004
5 4 5 5 3 3	540188	540563	540089
5 4 5 7 2 0	540493	540568	540005
5 4 5 7 2 1	540493	540568	540150
5 4 5 7 2 2	540493	540568	540004
5 4 5 7 2 3	540493	540568	540089
5 4 5 7 3 0	540493	540563	540005
5 4 5 7 3 1	540493	540563	540150
5 4 5 7 3 2	540493	540563	540004
5 4 5 7 3 3	540493	540563	540089

2
Universalteile/ Mechanik

Kzf.	Best.-Nr.	Typ	Kzf.	Best.-Nr.	Typ
0	540005	Exklusiv	2	540004	Robust
1	540150	Standard	3	540089	Economy

Steigrohr kpl.

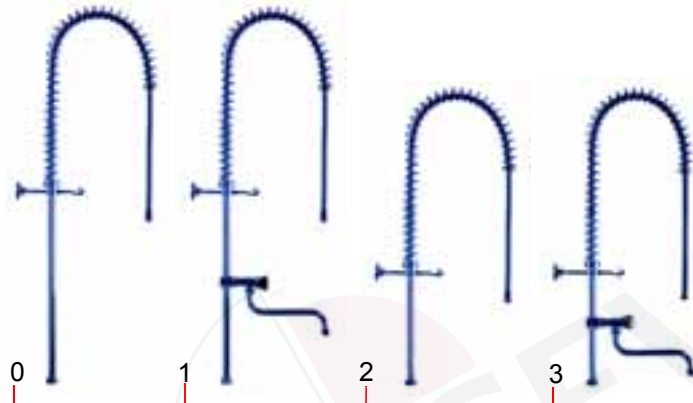

Kzf.	Best.-Nr.	Beschreibung	Kzf.	Best.-Nr.	Beschreibung
0	540566	lang	2	540568	kurz
1	540564	lang mit Schwenkventil	3	540563	kurz mit Schwenkventil

Unterteile

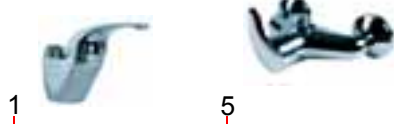

Kzf.	Best.-Nr.	Beschreibung	Kzf.	Best.-Nr.	Beschreibung
1	540351	Mischbatterie	5	540188	Wandmischbatterie

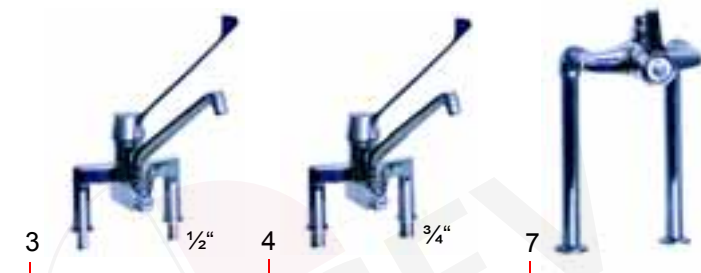

Kzf.	Best.-Nr.	Beschreibung	Kzf.	Best.-Nr.	Beschreibung
3	540186	Standmischbatterie mit Umstellung 1/2"	7	540493	Standmischbatterie
4	540187	Standmischbatterie mit Umstellung 3/4"			

Geschirrbrausen mit Export-Standardoberteilen 1/2"

Oberteil:

-Made in CE

Schlauch:

-CNS-Umflechtung u. PVC-Ummantelung mit KTW-Freigabe u. DVGW-Zulassung

Rückflussverhinderer:

-Für Wasserzulauf/ **nicht im Lieferumfang!** (Sonderzubehör)

Handbrausen



Kzf.	Best.-Nr.	Typ	Kzf.	Best.-Nr.	Typ
0	540005	Exklusiv	2	540004	Robust
1	540150	Standard	3	540089	Economy

Steigrohr kpl.

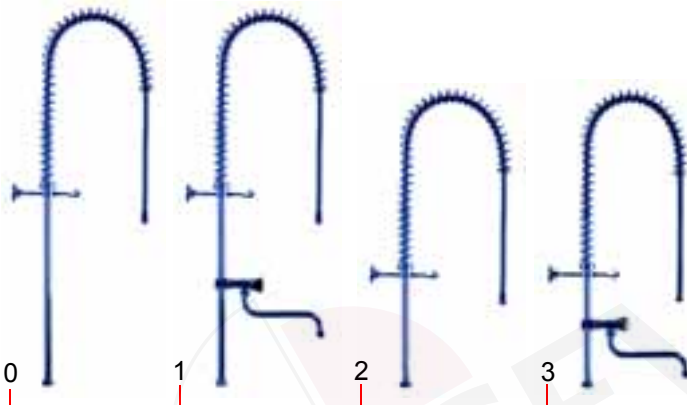

Kzf.	Best.-Nr.	Beschreibung	Kzf.	Best.-Nr.	Beschreibung
0	540560	lang	2	540562	kurz
1	540561	lang mit Schwenkventil	3	540569	kurz mit Schwenkventil

Unterteile



Kzf.	Best.-Nr.	Beschreibung	Kzf.	Best.-Nr.	Beschreibung
0	540433	Standventile	5	540434	Standmischbatterie
1	540432	Mischbatterie			



Kzf.	Best.-Nr.	Beschreibung	Kzf.	Best.-Nr.	Beschreibung
6	540441	Wandmischbatterie mit Umstellung	8	540495	Standmischbatterie mit Umstellung
7	540494	Standmischbatterie			

Best.-Nr. Geschirbr.kpl.	bestehend aus einzelnen Teilen		
	Unterteile	Steigrohr	Handbrause
5 4 6 0 0 0	540433	540560	540005
5 4 6 0 0 1	540433	540560	540150
5 4 6 0 0 2	540433	540560	540004
5 4 6 0 0 3	540433	540560	540089
5 4 6 0 1 0	540433	540561	540005
5 4 6 0 1 1	540433	540561	540150
5 4 6 0 1 2	540433	540561	540004
5 4 6 0 1 3	540433	540561	540089
5 4 6 1 0 0	540432	540566	540005
5 4 6 1 0 1	540432	540566	540150
5 4 6 1 0 2	540432	540566	540004
5 4 6 1 0 3	540432	540566	540089
5 4 6 1 1 0	540432	540561	540005
5 4 6 1 1 1	540432	540561	540150
5 4 6 1 1 2	540432	540561	540004
5 4 6 1 1 3	540432	540561	540089
5 4 6 5 2 0	540434	540562	540005
5 4 6 5 2 1	540434	540562	540150
5 4 6 5 2 2	540434	540562	540004
5 4 6 5 2 3	540434	540562	540089
5 4 6 5 3 0	540434	540569	540005
5 4 6 5 3 1	540434	540569	540150
5 4 6 5 3 2	540434	540569	540004
5 4 6 5 3 3	540434	540569	540089
5 4 6 6 2 0	540441	540562	540005
5 4 6 6 2 1	540441	540562	540150
5 4 6 6 2 2	540441	540562	540004
5 4 6 6 2 3	540441	540562	540089
5 4 6 7 2 0	540494	540562	540005
5 4 6 7 2 1	540494	540562	540150
5 4 6 7 2 2	540494	540562	540004
5 4 6 7 2 3	540494	540562	540089
5 4 6 7 3 0	540494	540569	540005
5 4 6 7 3 1	540494	540569	540150
5 4 6 7 3 2	540494	540569	540004
5 4 6 7 3 3	540494	540569	540089
5 4 6 8 2 0	540495	540562	540005
5 4 6 8 2 1	540495	540562	540150
5 4 6 8 2 2	540495	540562	540004
5 4 6 8 2 3	540495	540562	540089

Geschirrbrausen-Zubehör

Rücksaugverhinderer



Abb.	Best.-Nr. (VPE 2 Stck.)	Größe	Abb.	Best.-Nr. (VPE 2 Stck.)	Größe
1	540349	3/8"	3	540344	3/4"
2	540343	1/2"			

Wandhalter

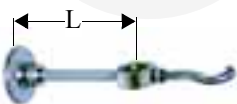

Pos.	Bestell-Nr.	L	Pos.	Bestell-Nr.	L
1	540007*	120mm	2	540345	315mm

* in der kpl. Ausführung enthalten

Geschirrbrausen-Ersatzteile

Diverses



Pos.	Best.Nr.	Beschreibung	Pos.	Best.-Nr.	Beschreibung
1	540340	Säulenpaar	2	540031	S-Auslauf 250mm

Oberteile



Abb.	Bestell-Nr.	Beschreibung
1	540446	mit Rückschlagventil für Mischbatterien (Standard)
2	540447	Griff
3	540018	kpl. für Standarddeckventile (Standard)
4	540359	mit Keramikventil

Einhebelmischer-Kartuschen



Abb.	Bestell-Nr.	Beschreibung
1	540625	für Einlochmischbatterie
2	540204	für Wandbatterie
3	540203	für Zweilochscharter

Geschirrbrausen-Ersatzteile

Steigrohre mit Federhalter



Ohne Abgang			Mit Keramikoberteil			Mit Standardoberteil		
Abb.	Best.-Nr.	L/ mm	Abb.	Best.-Nr.	L/ mm	Abb.	Best.-Nr.	L/ mm
1	540254	500	3	540366	500	3	540431	500
2	540037	690	4	540367	690	4	540148	690

Feder



Pos.	Bestell-Nr.	Material
1	540036	Stahl verchromt
2	540144	Edelstahl (CNS) poliert

Geschirrbrausenschläuche
CNS-Wellenschlauch

Technische Daten:

Anschlüsse: 1/2"
Arbeitsdruck: 10 bar
Platzdruck: 60 bar
Temperaturbeständigkeit: bis 90°C
KTW-Freigabe/ DVGW-Zulassung



Abb.	Bestell-Nr.	Länge in mm	Abb.	Bestell-Nr.	Länge in mm
1	540066	1000	2	540070	1250

Hytel-Schlauch

Technische Daten:

Anschlüsse: 1/2"
Arbeitsdruck: 10 bar
Platzdruck: 40 bar
Temperaturbeständigkeit: bis 90°C
KTW-Freigabe



Abb.	Bestell-Nr.	Länge in mm	Abb.	Bestell-Nr.	Länge in mm
1	540145	950	2	540146	1200

EPDM-Schlauch, CNS-umflochten, PVC-überzogen

Technische Daten:

Anschlüsse: 1/2"
Arbeitsdruck: 15 bar
Platzdruck: 40 bar
Temperaturbeständigkeit: bis 90°C



Pos.	Bestell-Nr.	Länge in mm
1	540578	1000mm

Ventile 1/2"

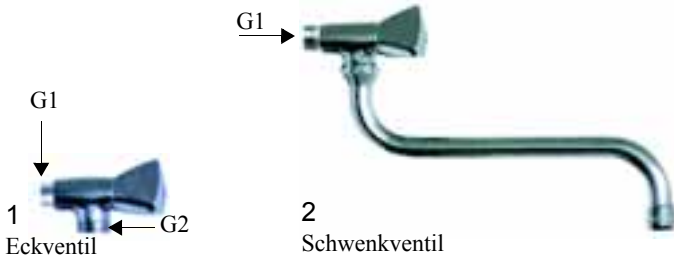

Mit Standard-Oberteil			Mit Keramik-Oberteil		
Pos.	Bestell-Nr.	Maße in mm G1 G2	Pos.	Bestell-Nr.	Maße in mm G1 G2
1	540021	1/2" 3/4"	2	540356	1/2" 3/4"
2	540177	1/2"	3	540381	1/2"

Handbrausen-Ersatzteile für 540005



Abb.	Bestell-Nr.	Beschreibung
1	540444	Druckstift mit Dichtung
2	540091	Druckstift-Feder
3	540443	Brausekopf 1/2"
4	540008	Brausekopf 1/2"

Für 540311



Abb.	Bestell-Nr.	Beschreibung
1	540428	Druckstift mit Dichtung
2	540429	Druckstift-Feder
3	540430	Druckstift-Dichtungssatz
4	540443	Brausekopf 1/2"
5	540008	Brausekopf 1/2"

Für 540150



Abb.	Bestell-Nr.	Beschreibung
1	540530	Kunststoffteil
2	540531	Hebelhalter
3	543105	Hebel
4	543107	Gelenkstück
5	543118	Reparatursatz



Abb.	Bestell-Nr.	Beschreibung
1	540532	Feder
2	543115	Stoß-Ring
3	543114	Brausekopf aussen
4	543116	Brausekopf innen

Für 540004

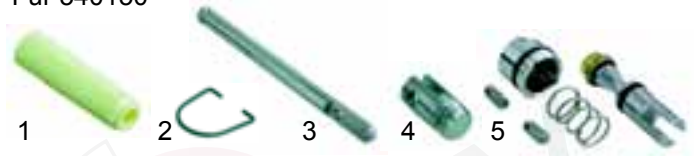

Abb.	Bestell-Nr.	Beschreibung
1	540421	Druckstift mit Dichtung
2	540422	Druckstift-Feder
3	540423	Sieb
4	540424	O-Ring
5	540425	Siebträger
6	540426	Druckstift-Dichtungssatz

Geräte-Reinigung

Gerätebrause 1/2"



Abb.	B.-Nr.	Beschreibung	Abb.	B.-Nr.	Beschreibung
1	540003	Economy	3	540602	Standard
2	540149	Klassik			



Abb.	B.-Nr.	Beschreibung	Abb.	B.-Nr.	Beschreibung
1	540158	Exklusiv (Echtermann) DVGW-Zulassung	2	540587	Drehbarer Schlauchanschluss



Abb.	B.-Nr.	Beschreibung	Abb.	B.-Nr.	Beschreibung
1	540553	regulierbar, mit 1/2" Kupplungsanschluss	2	540554	Für Spülmittelbehälter mit 1/2" Kupplungsanschluss



Pos.	B.-Nr.	Beschreibung	Pos.	B.-Nr.	Beschreibung
1	540557	Spülmittelbehälter, 1,35L	2	540558	Spülmittelbehälter, 2,7L

Armaturen



Abb.	B.-Nr.	Beschreibung	Abb.	B.-Nr.	Beschreibung
1	540601	Eckventil, 1/2" - 1/2"	2	540073	Rohrbelüfter kpl., mit Rücksaugverhinderer

Zubehör



Abb.	B.-Nr.	Beschreibung	Abb.	B.-Nr.	Beschreibung
1	540002	Wandhalter	2	540001	Drehkupplung für 1/2"-Schlauch

Schläuche 1/2"

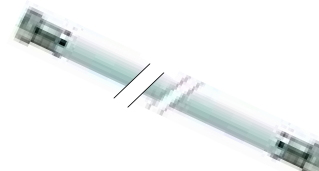

Technische Daten:

Schlauch in EPDM
Außen: Nylon-umflochten
Arbeitsdruck: 10bar
Platzdruck: 50bar
Temperaturbeständigkeit: 90°C

Pos.	B.-Nr.	Länge in mm	Pos.	B.-Nr.	Länge in mm
1	540603	1000	3	540605	2000
2	540604	1500			



Technische Daten:

Schlauch in EPDM
Außen: Wellenschlauch/ Messing-vern
Arbeitsdruck: 10bar
Platzdruck: 115bar
Temperaturbeständigkeit: 60°C

Abb.	B.-Nr.	Länge in mm	Abb.	B.-Nr.	Länge in mm
1	540063	1000	3	540065	2000
2	540064	1250			

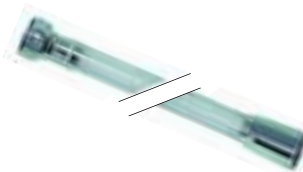

Technische Daten:

Schlauch: PVC-Gewebe
Arbeitsdruck: 10bar
Platzdruck: 30bar
Temperaturbeständigkeit: 60°C

Abb.	B.-Nr.	Länge in mm	Abb.	B.-Nr.	Länge in mm
1	520272	1000	4	520097	2200
2	520277	1500	5	520098	2600
3	520096	2000			

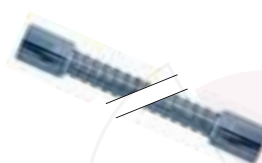

Technische Daten:

Schlauch in EPDM
Außen: CNS-Wellenschlauch
Arbeitsdruck: 10bar
Platzdruck: 60bar
Temperaturbeständigkeit: 90°C

Abb.	B.-Nr.	Länge in mm	Abb.	B.-Nr.	Länge in mm
1	540066	1000	4	540230	2000
2	540070	1250	5	540231	2500
3	540224	1500	6	540239	3000

Schlauchroller und Reinigungsbrausen

Reinigungsbrausen



1



2

Abb.	B.-Nr.	Beschreibung
1	540300	1/2" Innengewinde/ Messingausführung

Abb.	B.-Nr.	Beschreibung
2	540401	1/2" Innengewinde/ Edelstahl-ausführung



Pos.	Best.-Nr.	Beschreibung
1	540550	3/4" Innengewinde, Reinigungsbrause für Schaumlanze mont.



1



2



3

Abb.	B.-Nr.	Beschreibung
1	540372	1/2" Innengewinde
2	540479	Kupplung

Abb.	B.-Nr.	Beschreibung
3	540373	Schaumlanze 30cm



1



2

3

Abb.	B.-Nr.	Beschreibung
1	540551	3/4" Innengewinde
2	540535	Düse/ kurz

Abb.	B.-Nr.	Beschreibung
3	540536	Schaumlanze 17cm

Schlauchroller



Pos.	Bestell-Nr.	Beschreibung
1	540400	Edelstahl-Schlauchroller/ kpl., mit 20m Spritzschlauch 1/2" (DN13) und 2m Zulaufschlauch



Pos.	Bestell-Nr.	Beschreibung
1	540404	Edelstahl-Schlauchroller ohne Schlauch (max 20m, 1/2" (DN13))

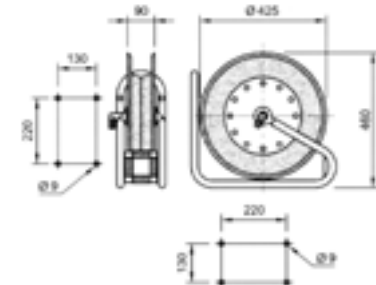

Pos.	Bestell-Nr.	Beschreibung
1	540635	Kunststoff/ Edelstahl-Schlauchroller ohne Schlauch (max 10m 1/2" - DN13)

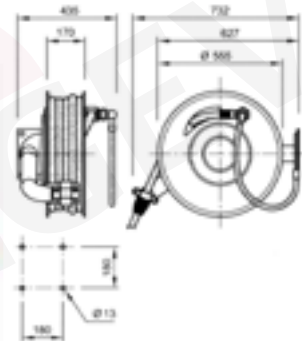

Pos.	Bestell-Nr.	Beschreibung
1	540636	Edelstahl-Schlauchroller, Hygiene-Ausführung ohne Schlauch (max 25m 1/2" DN13)

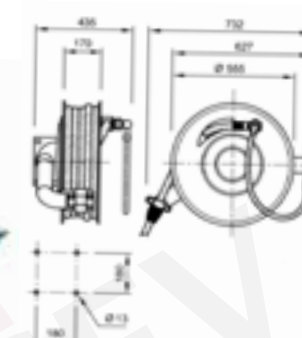

Pos.	Bestell-Nr.	Beschreibung
1	540637	Edelstahl-Schlauchroller, Hygiene-Ausführung ohne Schlauch (max 18m 3/4" DN19)

Wandhalter



Pos.	Bestell-Nr.	Beschreibung
1	540406	Wandhalter aus CNS für 25m 1/2" Schlauch oder 20m 3/4" Schlauch

Schläuche



Technische Daten:
 Spritzschlauch kpl.
 (DN13m-1/2"),
 kpl. mit Edelstahlanschlüssen,
 Pistolenseite: mit Drehkupplung

Pos.	B.-Nr.	Länge in m	Pos.	B.-Nr.	Länge in m
1	540405	15	2	540402	20



Technische Daten:
 Zulaufschlauch kpl. (DN13-1/2"), Schlauch-
 rollerseite: Schlauchstutzen 1/2" Edelstahl,
 Anschlussseite: Schnellkupplung mit 3/4"
 Anschluss/ Messing verchromt

Pos.	Bestell-Nr.	Länge in m
1	540403	2 (kürzbar)

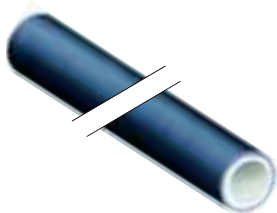

Technische Daten:
 Meterware, LMBG-Freigabe,
 ohne Verschraubungsteile,
 In 2 Größen lieferbar:
 DN13 (1/2"), DN19 (3/4")

Pos.	B.-Nr.	Länge/ m	Größe	Pos.	B.-Nr.	Länge/ m	Größe
1	520100	5	DN13	4	520254	5	DN19
2	520101	20	DN13	5	520255	20	DN19
3	520095	40	DN13	6	520109	40	DN19

Verschraubungsteile (Messing)

Schlauchstutzen



AG = Außengewinde

Pos.	B.-Nr.	Größe	Pos.	B.-Nr.	Größe
1	520677	3/8"AG-12mm (1/2")	3	540474	1/2"AG-19mm (3/4")
2	540473	1/2"AG-13mm (1/2")			

Schlauchverbinder



Pos.	Bestell-Nr.	Größe	Pos.	Bestell-Nr.	Größe
1	540498	13mm (1/2")	2	540499	19mm (3/4")

Schlauchverschraubung



Pos.	B.-Nr.	Größe	Pos.	B.-Nr.	Größe
1	540510	3/4"IG-13mm (1/2")	2	540511	3/4"IG-19mm (3/4")

Verschraubungsteile (Messing-verchromt)

Doppelnippel



Pos.	B.-Nr.	Größe	Pos.	B.-Nr.	Größe
1	520167	3/8"AG - 1/2"AG	3	520208	1/2"AG - 3/4"AG
2	520162	1/2"AG - 1/2"AG			

Schlauchstutzen



Pos.	B.-Nr.	Größe	Pos.	B.-Nr.	Größe
1	520203	1/2"AG - 13mm	2	540644	1/2"AG - 19mm

Kupplungen DN13-Stecker



Abb.	Bestell-Nr.	Größe	Abb.	Bestell-Nr.	Größe
1	540484	1/2"AG	3	540486	1/2"IG
2	540514	3/4"AG	3	540487	3/4"IG
			4	540515	13mm (1/2")

Kupplungen DN13-Buchse

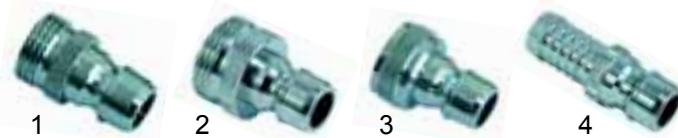

Abb.	Bestell-Nr.	Größe	Abb.	Bestell-Nr.	Größe
1	540516	1/2" IG	2	540641	1/2" AG
1	540640	3/4" IG	2	540642	3/4" AG
			3	540485	13mm (1/2")
			3	540643	19mm (3/4")

Kupplungen DN19-Stecker



Abb.	Bestell-Nr.	Größe	Abb.	Bestell-Nr.	Größe
1	540488	1/2" AG	2	540518	19mm (3/4")

Kupplungen DN19-Buchse



Abb.	Bestell-Nr.	Größe	Abb.	Bestell-Nr.	Größe
1	540519	3/4" IG	2	540489	19mm (3/4")

Verschraubungsteile (Edelstahl)

Schlauchstutzen



Abb.	B.-Nr.	Größe	Abb.	B.-Nr.	Größe
1	540475	1/2" AG-13mm (1/2")	3	540513	1/2" IG-13mm
1	540476	1/2" AG-19mm (3/4")	3	540645	1/2" IG-19mm
2	540512	1/2" IG-13mm (1/2")			

Drehbare Teile



Abb.	B.-Nr.	Größe	Abb.	B.-Nr.	Größe
1	540477	1/2" AG-13mm (1/2")	2	540524	1/2" AG-1/2" IG
1	540478	1/2" AG-19mm (1/2")	3	540525	1/2" AG-1/2" AG

Kupplungen, DN13-Stecker



Abb.	Bestell-Nr.	Größe	Abb.	Bestell-Nr.	Größe
1	540520	3/8" AG	2	540522	1/2" IG
1	540521	1/2" AG			

Kupplungen, DN13-Buchse



Abb.	Bestell-Nr.	Größe	Abb.	Bestell-Nr.	Größe
1	540479	1/2" IG	2	540523	1/2" AG

Spülmittelmischsysteme



Technische Daten:

DVGW-Zulassung
Schnellkupplungsanschluss
Mischverhältnis 0,15% - 10%
(je nach Düse)

Pos.	B.-Nr.	Fördermenge	Pos.	B.-Nr.	Fördermenge
1	540552	5L/ min., inkl. Montagekit	2	540559	12L/ min., inkl. Montagekit

Minispray



Technische Daten:

DVGW-Zulassung
Schnellkupplungsanschluss
Mischverhältnis 0,15% - 10%
(je nach Düse)
Gehäuse aus Edelstahl

Pos.	B.-Nr.	Fördermenge	Pos.	B.-Nr.	Fördermenge
1	540555	5L/ min.	2	540556	12L/ min.

KLYN



Technische Daten:

DVGW-Zulassung
3/4" Anschluss
Mischverhältnis 0,5% - 11%
(je nach Düse)

Pos.	B.-Nr.	Fördermenge	Pos.	B.-Nr.	Fördermenge
1	540647	für 1 Produkt	2	540648	für 2 Produkte

Ablaufventil 1/2"



Material:
Ablaufventil MS-verchromt



Pos.	Bestell-Nr.	Typ	D/mm	H/mm	G
1	515040	A	28	13	1/2"
2	515044	B	28	19	1/2"

Ablaufventil 3/4"



Material:
Ablaufventil MS-verchromt

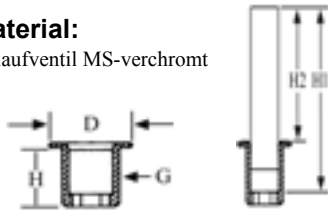

Pos.	Bestell-Nr.	D/mm	H/mm	G
1	515041	38	30	3/4"

Standrohr

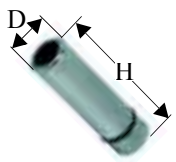

Material:
Standrohr MS-verchromt

Pos.	Best.-Nr.	Maße in mm			Pos.	Best.-Nr.	Maße in mm		
		D	H1	H2			D	H1	H2
1	515047	20	54	30	3	515049	20	94	70
2	515048	20	74	50	4	515050	20	124	100

Ablaufventil 1 1/2"



Material:
Ablaufventil MS-verchromt

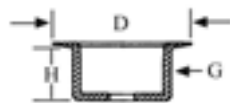

Pos.	Bestell-Nr.	D/mm	H/mm	G
1	515042	67,5	28	1 1/2"

Standrohr

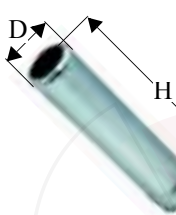

Material:
Standrohr CNS

Pos.	Best.-Nr.	Maße in mm			Pos.	Best.-Nr.	Maße in mm		
		D	H1	H2			D	H1	H2
1	515051	40	180	168	3	515053	40	270	258
1	515052	40	230	218	3	515054	40	320	308

Ablaufventil 2"



Material:
Ablaufventil MS-verchromt

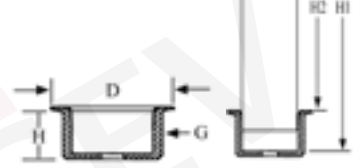

Pos.	Bestell-Nr.	D/mm	H/mm	G
1	515043	74	30	2"

Standrohr

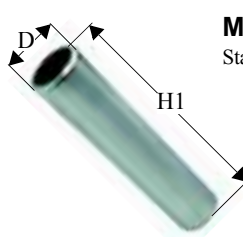

Material:
Standrohr CNS

Pos.	Best.-Nr.	Maße in mm			Pos.	Best.-Nr.	Maße in mm		
		D	H1	H2			D	H1	H2
1	515055	50	180	168	3	515057	50	270	258
2	515056	50	230	218	4	515058	50	320	308

Ablaufventil 1 1/4"-1 1/2"



Material:
Ablaufventil MS-verchromt

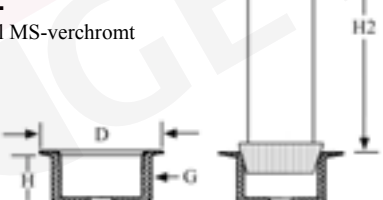

Pos.	Bestell-Nr.	D/mm	H/mm	G
1	540277	59	36	1 1/4"
2	515045	68	30	1 1/2"

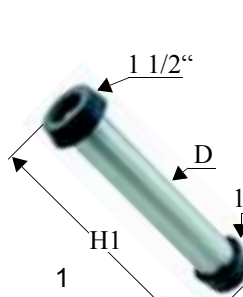

Standrohr CNS
mit Gummi-Konus

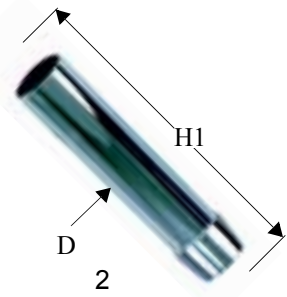

Standrohr MS-verchromt

Abb.	Best.-Nr.	Maße in mm			Abb.	Best.-Nr.	Maße in mm		
		D	H1	H2			D	H1	H2
1	540279	30	185	170	2	515029	32	215	200
1	540280	30	225	210	2	515030	32	215	300
1	540281	30	275	260	2	515031	32	265	250

CNS-Flex Schläuche

Norm

EN50084-DIN-VDE 0700/600

Zulassungen/ DVGW, SVGW, KIWA, CST Bat

Technische Daten:

Arbeitsdruck: 10bar
 Prüfdruck: 32bar
 Platzdruck: 95bar
 Temperatur: max 110°C
 Nennweite: DN6 Innen 6mm
 DN8 Innen 8mm
 DN10 Innen 9,3mm
 DN12 Innen 12mm

Flachdichtend



Pos.	Bestell-Nr.	Nennweite	G1	G2	Länge
1	520610	DN6	1/8"	1/8"	300mm
2	520611	DN6	1/8"	1/8"	600mm
3	540265	DN10	3/8"	3/8"	300mm
4	540266	DN10	3/8"	3/8"	500mm
5	520568	DN10	3/8"	3/8"	750mm
6	520567	DN10	3/8"	3/8"	1000mm
7	520612	DN12	1/2"	1/2"	1000mm
8	520613	DN12	1/2"	1/2"	1500mm
9	520614	DN12	3/4"	3/4"	1000mm
10	520615	DN12	3/4"	3/4"	1500mm

Flachdichtend



Pos	Bestell-Nr.	Nennweite	G1	G2	Länge
1	520569	DN8	3/8"	3/8"	370mm
2	520570	DN8	3/8"	3/8"	2000mm
3	520563	DN10	1/2"	1/2"	1000mm
4	520564	DN10	1/2"	1/2"	1500mm
5	520565	DN10	1/2"	1/2"	2500mm
6	520005	DN10	3/4"	3/4"	1500mm
7	520006	DN10	3/4"	3/4"	2500mm
8	520008	DN12	3/4"	3/4"	1500mm
9	520009	DN12	3/4"	3/4"	2500mm

Dichtungen/ VPE 10 Stck.



Abb.	Bestell-Nr.	G	Abb.	Bestell-Nr.	G
1	521138	3/8"	1	520054	3/4"
1	520055	1/2"	2	520053	3/4"

Anschlussschläuche EPDM/ CNS-umflochten
 KTW-Freigabe/ DVGW-Zulassung

Technische Daten:

Arbeitsdruck: 15bar
 Prüfdruck: 100bar
 Temperatur: max 100°C

1/2" IG 3/8" AG

Pos.	Bestell-Nr.	Länge	Größe
1	520104	500mm	DN10

3/8" IG 10mm Rohr

Pos. B.-Nr.	Länge	Größe	Pos. B.-Nr.	Länge	Größe		
1	540263	300mm	DN8	2	540264	500mm	DN8

10mm Rohr 10mm

Pos. B.-Nr.	Länge	Größe	Pos. B.-Nr.	Länge	Größe		
1	540261	300mm	DN8	2	540262	500mm	DN8

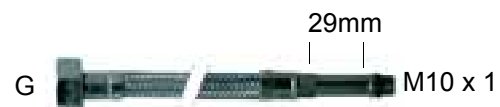

Pos. B.-Nr.	G	L/ mm	Größe	Pos. B.-Nr.	G	L/ mm	Größe		
1	520105	3/8"	500mm	DN8	1	520102	1/2"	500	DN8



Pos. B.-Nr.	G	L/ mm	Größe	Pos. B.-Nr.	G	L/ mm	Größe		
1	520106	3/8"	500	DN8	2	520103	1/2"	500	DN8

Zulaufschläuche, EPDM



Technische Daten:

Arbeitsdruck: 30bar
 Prüfdruck: 60bar
 Temperatur: max 90°C

Pos. B.-Nr.	VPE	Größe (mm)	Pos. B.-Nr.	VPE	Größe (mm)
1	520015	5m 10 x 17 (3/8")	3	520017	5m 13 x 20 (1/2")
2	520014	40m 10 x 17 (3/8")	4	520016	40m 13 x 20 (1/2")

Wasserschläuche (Goldschlange)



Technische Daten:

Arbeitsdruck: 30bar
 Prüfdruck: 50bar
 Temperatur: max 100°C
 Zulassung: KTW-Freigabe

Pos. B.-Nr.	VPE	Größe (mm)	Pos. B.-Nr.	VPE	Größe (mm)
1	530540	5m 13 x 19,5 (1/2")	2	530538	40m 13 x 19,5 (1/2")

2

Universalteile/ Mechanik

Universalschläuche/ Niplaflex



Technische Daten:

Arbeitsdruck: 25bar
 Prüfdruck: 75bar
 Temperatur: max 70°C

Pos.	B.-Nr.	VPE	Größe (mm)
1	530561	5m	10 x 17 (3/8")
2	570561	100m	10 x 17 (3/8")

Pos.	B.-Nr.	VPE	Größe (mm)
3	530562	5m	13 x 21 (1/2")
4	570562	100m	13 x 21 (1/2")

PVC-Gewebesschläuche mit SKJ-Zeichen

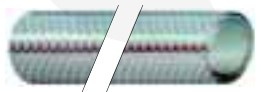

Technische Daten:

Arbeitsdruck: 10bar
 Prüfdruck: 30bar
 Temperatur: max 70°C

Pos.	B.-Nr.	VPE	Größe (mm)
1	520030	10m	6 x 12
2	520048	20m	6 x 12
3	570048	50m	6 x 12

Pos.	B.-Nr.	VPE	Größe (mm)
4	520049	10m	8 x 14
5	520144	20m	8 x 14
6	570049	50m	8 x 14

PVC-Gewebesschläuche

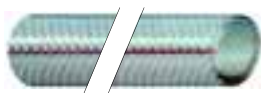

Technische Daten:

Arbeitsdruck: 10bar
 Prüfdruck: 30bar
 Temperatur: max 60°C

Pos.	B.-Nr.	VPE	Größe (mm)
1	520018	5m	4 x 10
2	570018	100m	4 x 10
3	520019	5m	6 x 12
4	570020	50m	6 x 12

Pos.	B.-Nr.	VPE	Größe (mm)
5	530564	10m	10 x 16 (3/8")
6	570564	50m	10 x 16m(3/8")
7	530565	10m	13 x 19 (1/2")
8	570565	50m	13 x 19 (1/2")

Pressostat-Schläuche



Technische Daten:

Arbeitsdruck: 15bar
 Prüfdruck: 60bar
 Temperatur: max 90°C

Pos.	B.-Nr.	VPE	Größe (mm)
1	530563	5m	4 x 9
2	570563	100m	4 x 9

Pos.	B.-Nr.	VPE	Größe (mm)
3	530560	5m	5 x 10
4	570560	100m	5 x 10

Gastrotop-Schläuche



Technische Daten:

Arbeitsdruck: 10bar
 Prüfdruck: 30bar
 Temperatur: max 70°C
 LMBG-Freigabe

Pos.	B.-Nr.	VPE	Größe (mm)
1	520100	5m	13 x 19 (1/2")
2	520101	20m	13 x 19 (1/2")
3	520095	40m	13 x 19 (1/2")

Pos.	B.-Nr.	VPE	Größe (mm)
4	520254	5m	19 x 27 (3/4")
5	520255	20m	19 x 27 (3/4")
6	520109	40m	19 x 27 (3/4")

Nylon-Schläuche



Technische Daten:

Arbeitsdruck: 10bar
 Prüfdruck: 50bar
 Temperatur: max 100°C

Pos.	B.-Nr.	VPE	Größe (mm)
1	520091	2m	4 x 6mm
2	520031	5m	4 x 6mm
3	520251	50m	4 x 6mm
4	520252	5m	6 x 8mm

Pos.	B.-Nr.	VPE	Größe (mm)
5	520253	50m	6 x 8mm
6	530566	5m	8 x 10m
7	570566	50m	8 x 10mm

PVC-Schläuche



Technische Daten:

Temperatur: max 60°C

Pos.	B.-Nr.	VPE	Größe (mm)
1	520090	2m	4 x 6
2	520026	10m	4 x 6
3	570026	100m	4 x 6
4	520027	10m	4 x 7
5	57027	100m	4 x 7
6	520046	10m	5 x 8
7	570046	100m	5 x 8

Pos.	B.-Nr.	VPE	Größe (mm)
8	520028	10	6 x 8
9	570028	100m	6 x 8
10	520029	10m	6 x 9
11	570029	100	6 x 9
12	520022	10	8 x 12
13	570022	100m	8 x 12

Saug- und Druckschläuche



Technische Daten:

Arbeitsdruck: 10bar
 Prüfdruck: 30bar
 Temperatur: max 80°C

Pos.	B.-Nr.	VPE	Größe (mm)
1	530340	0,5m	25 x 35
2	530440	1,0m	25 x 35
3	530341	0,5m	28 x 38
4	530441	1,0m	28 x 38
5	530342	0,5m	32 x 43
6	530442	1,0m	38 x 43
7	530343	0,5m	35 x 46
8	530443	1,0m	35 x 46
9	530344	0,5m	38 x 50
10	530444	1,0m	38 x 50
11	530345	0,5m	40 x 53
12	530445	1,0m	40 x 53

Pos.	B.-Nr.	VPE	Größe (mm)
13	530346	0,5m	42 x 55
14	530446	1,0m	42 x 55
15	530347	0,5m	45 x 59
16	530447	1,0m	45 x 59
17	530348	0,5m	48 x 61
18	530448	1,0m	48 x 61
19	530349	0,5m	50 x 64
20	530449	1,0m	50 x 64
21	530350	0,5m	60 x 74
22	530450	1,0m	60 x 74
23	530351	0,5m	63 x 79
24	530451	1,0m	63 x 79

Schläuche für Schlauchpumpen (Silikon)



Pos.	B.-Nr.	VPE	Größe (mm)
1	361601	5m	2,0 x 5,2
2	361602	5m	2,5 x 5,7
3	361603	5m	3,0 x 5,0
4	361604	5m	3,0 x 6,0
5	361605	5m	3,0 x 7,0

Pos.	B.-Nr.	VPE	Größe
6	361606	5m	4,0 x 7,0
7	361607	5m	4,0 x 7,2
8	361608	5m	4,0 x 8,0
9	361609	5m	5,0 x 8,0
10	361610	5m	5,0 x 9,0

Schläuche für Schlauchpumpen (Santopren)

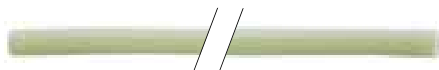

Pos.	B.-Nr.	VPE	Größe (mm)
1	361631	5m	2,4 x 5,6
2	361632	5m	3,0 x 5,0
3	361633	5m	3,2 x 6,4
4	361634	5m	4,0 x 6,0
5	361635	5m	4,0 x 7,0

Pos.	B.-Nr.	VPE	Größe
6	361636	5m	4,0 x 8,0
7	361637	5m	5,0 x 8,0
8	361638	5m	6,0 x 9,0
9	361639	5m	6,0 x 10,0
10	361640	5m	7,0 x 10,0

Ablaufschläuche

Meterware



Technische Daten:

Temperatur: max 110°C
Schlauch/ InnenØ: 19mm

Pos.	Bestell-Nr.	VPE	Pos.	Bestell-Nr.	VPE
1	520020	5m	2	570120	15m



Technische Daten:

Temperatur: max 110°C
Schlauch/ InnenØ: 22mm

Pos.	Bestell-Nr.	VPE	Pos.	Bestell-Nr.	VPE
1	520021	5m	2	570021	15m

Endstück



Pos.	Bestell-Nr.	Größe	Schlauch-Typ	Pos.	Bestell-Nr.	Größe	Schlauch-Typ
1	520040	19mm	19mm	3	520043	28mm	19mm
2	520041	22mm	19mm	4	520042	22mm	22mm

Endstück, einseitig gerade



Pos.	Bestell-Nr.	Länge	G1	G2	Pos.	Bestell-Nr.	Länge	G1	G2
1	508043	2,0m	28/21	19	3	530587	2,0m	32	28
2	524257	1,8m	28	21	4	530615	1,0m	58	

Endstück, einseitig gebogen

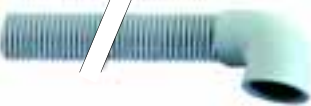

Pos.	Bestell-Nr.	Länge	G1	G2	Pos.	Bestell-Nr.	Länge	G1	G2
1	505081	1,5m	32	24	3	505082	1,5m	48	24
2	530568	2,0m	40	34	4	518068	2,0m	48	34

Endstück, beidseitig gerade



Pos.	Bestell-Nr.	Länge	G1	G2	Pos.	Bestell-Nr.	Länge	G1	G2
1	530630	1,5m	28/21	21	7	507207	1,5m	24	24
2	530570	2,0m	28/21	21	8	504059	1,5m	28	28
3	530631	2,5m	28/21	21	9	507211	1,5m	32	32
4	530632	3,5m	28/21	21	10	530573	1,5m	40	34
5	507329	1,5m	21	19	11	530574	2,0	40	34
6	501136	2,5	21	19	12	530575	1,1	40	35

Endstück, gebogen/ gerade

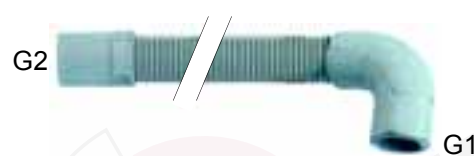

Pos.	Bestell-Nr.	Länge	G1	G2	Pos.	Bestell-Nr.	Länge	G1	G2
1	505084	2,0m	19	19	6	530571	1,5m	28	24
2	530635	1,5m	21	28/21	7	530572	2,0m	28	24
3	530636	2,0m	21	28/21	8	506208	1,5m	42	24
4	530637	2,5m	21	28/21	9	519272	1,5m	42	32
5	530638	3,5m	21	28/21					

Endstück, beidseitig gerade (ausdehnbar)



Pos.	Bestell-Nr.	Länge	G1	G2	Pos.	Bestell-Nr.	Länge	G1	G2
1	530640	0,6-2,0m	28/21	21	2	530612	1,1-4,0m	28/21	21

Ablaufventilbogen



1
Messing/ kpl.



2
Kunststoff

Abb.	Bestell-Nr.	G	Ø	Abb.	Bestell-Nr.	G	Ø
1	515033	1"	26	2	515093	1¼"	32
1	515034	1¼"	32	2	515094	1½"	40
1	515035	1½"	40				



1



2

Abb.	Bestell-Nr.	G	Ø	Abb.	Bestell-Nr.	G	Ø
1	515036	1¼"	40	2	515095	1¼"	40-50
1	515037	1½"	40	2	515096	1½"	40-50

Ablaufventilanschluss



1



2

Abb.	Bestell-Nr.	G	Ø	Abb.	Bestell-Nr.	G	Ø
1	515097	1¼"	32mm	2	515099	1¼"	40mm
1	515098	1½"	40mm	2	515100	1½"	40mm

Ablaufventilreduzierung



Abb.	Bestell-Nr.	IG	AG	Abb.	Bestell-Nr.	IG	AG
1	515038	1/4"	1"	2	515102	1/4"	1"
1	515039	1/2"	1/4"	2	515103	1/2"	1/4"
2	515101	1"	1/4"	2	515104	2"	1/2"

Fittings

Doppelnippel



Abb.	Bestell-Nr.	G1	G2	Abb.	Bestell-Nr.	G1	G2
1	520160	1/8"	1/8"	1	520162	1/8"	3/8"
1	520163	1/4"	1/4"	1	520164	1/4"	3/8"
1	520166	3/8"	3/8"	1	520165	1/4"	1/2"
1	520168	1/2"	1/2"	1	520167	3/8"	1/2"
2	520169	3/4"	3/4"	2	520218	3/8"	3/4"
2	520171	1"	1"	2	520208	1/2"	3/4"
1	520161	1/8"	1/4"	2	520170	1"	3/4"

Verlängerung

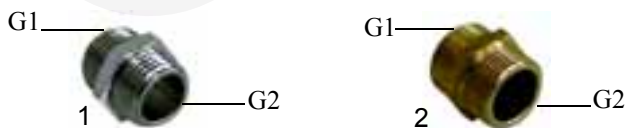

Abb.	Bestell-Nr.	G1	G2	Abb.	Bestell-Nr.	G1	G2
3	520177	1/8"	1/4"	4	520184	1/8"	1/8"
3	520178	1/8"	3/8"	4	520185	1/8"	1/4"
3	520179	1/4"	3/8"	4	520186	1/4"	1/4"
3	520180	1/4"	1/2"	4	520187	1/4"	3/8"
3	520181	3/8"	1/2"	4	520188	3/8"	3/8"
3	520209	3/8"	3/4"	4	520189	3/8"	1/2"
3	520182	1/2"	3/4"	4	520190	1/2"	1/2"
3	520183	3/4"	1"	4	520184	1/8"	1/8"

Muffe

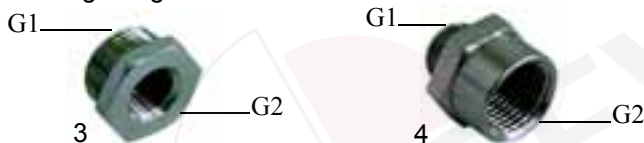

Abb.	Bestell-Nr.	G1	G2	Abb.	Bestell-Nr.	G1	G2
5	520172	1/8"	1/8"	5	520207	1/8"	1/4"
5	520173	1/4"	1/4"	5	520191	1/8"	3/8"
5	520174	3/8"	3/8"	5	520192	1/4"	3/8"
5	520175	1/2"	1/2"	5	520193	1/4"	1/2"
5	520176	3/4"	3/4"	5	520194	3/8"	1/2"

Einschraubtülle



Pos.	Best.-Nr.	G	D	Pos.	Bestell-Nr.	G	D
1	520195	1/8"	7mm	7	520201	1/4"	12mm
2	520196	1/4"	7mm	8	520202	3/8"	12mm
3	520197	1/8"	8mm	9	520203	1/2"	12mm
4	520198	1/8"	9mm	10	520204	3/8"	17mm
5	520199	1/4"	9mm	11	520205	1/2"	17mm
6	520200	3/8"	9mm	12	520206	3/4"	19mm

T-Stücke Messing vernickelt



Abb.	Best.-Nr.	L1/mm	L2/mm	G	Abb.	Best.-Nr.	L1/mm	L2/mm	G
1	520340	49	25	1/4"	2	520343	46	23	1/4"
1	520341	54	28	3/8"	2	520344	52	25	3/8"
1	520342	64	32	1/2"	2	520345	59	30	1/2"

Verschraubungen, Rohre



Abb.	Bestell-Nr.	L1/mm	L2/mm	Abb.	Bestell-Nr.	L1/mm	L2/mm
1	540057	8mm	3/8"	1	540060	10mm	1/2"
1	540058	10mm	3/8"	1	540061	12mm	1/2"
1	540059	12mm	3/8"	2	540050	3/8"	1/2"

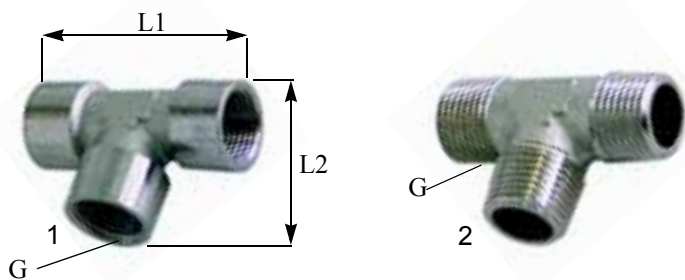

Abb.	Bestell-Nr.	D	G1	Abb.	Bestell-Nr.	G1	G2
3	540044	10mm	3/8"	4	540046	-	1/2"
3	540045	10mm	1/2"				

Kugelhähne

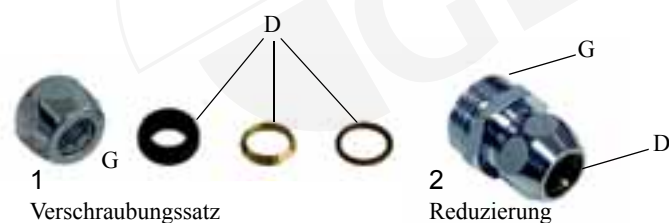
Technische Daten

Temperaturbereich: 180°C
 Kugel: Messing verchromt
 Dichtung: PTFE (Teflon)

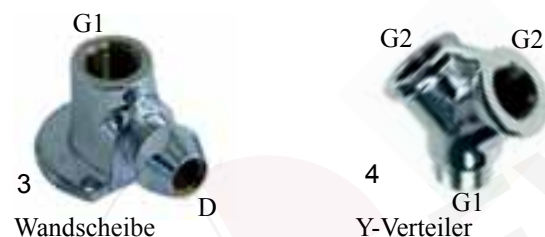

Abb. Bestell-Nr.	D	G1	Abb. Bestell-Nr.	D	G1
5 540047	8mm	3/8"	6 540053	12mm	1/2"
5 540048	10mm	3/8"	7 540054	8mm	3/8"
5 540049	12mm	1/2"	7 540055	10mm	3/8"
6 540051	8mm	3/8"	7 540056	12mm	1/2"
6 540052	10mm	3/8"			



Abb. Bestell-Nr.	L1/mm	Abb. Bestell-Nr.	L1/mm
1 520280	1/2"	2 520283	1/2"
1 520281	3/4"	2 520284	3/4"
1 520282	1"	2 520285	1"

Eckventile und Rohrverschraubungen



Abb. Bestell-Nr.	G1	G2	G3
1 540041	1/2"	3/8"/10mm	3/4"
2 540042	1/2"	3/8"/10mm	
3 540043	1/2"	3/8"/10mm	

Minikugelhähne



Abb. Bestell-Nr.	G	Abb. Bestell-Nr.	G
1 520720	1/8"	2 520721	1/8"
1 520294	1/4"	2 520722	1/4"
1 520295	3/8"	2 520723	3/8"
1 520296	1/2"	2 520724	1/2"
1 520297	3/4"	2 520725	3/4"

Cu-Rohr verchromt



Pos. Bestell-Nr.	VPE	D	Pos. Bestell-Nr.	VPE	D
1 540067	5m	8mm	3 540069	5m	12mm
2 540068	5m	10mm			

Rohrverschraubungen

T-Stück



Abb. Bestell-Nr.	L1/mm	L2/mm	D/mm	Abb. Bestell-Nr.	L1/mm	L2/mm	D/mm
1 520346	78	40	16	2 520348	38	38	15
1 520347	88	44	15	2 520349	44	44	16

Kugelhähne

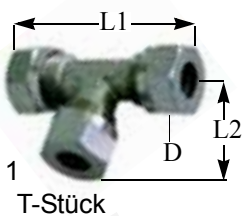

Abb. Bestell-Nr.	G	L/mm	Abb. Bestell-Nr.	G	L/mm	D/mm
1 520350	1/2"	49	3 520354	1/2"	55	15
1 520351	3/4"	58	3 520355	3/4"	64	16
2 520352	1/2"	45	4 520356			
2 520353	3/4"	52				

Muffenschieber

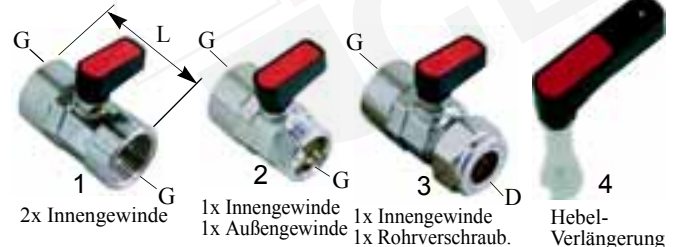

Pos. Bestell-Nr.	G	Pos. Bestell-Nr.	G
1 520290	1/2"	3 520292	1"
2 520291	3/4"	4 520293	1 1/4"

Druckminderer/ Rückschlagventil

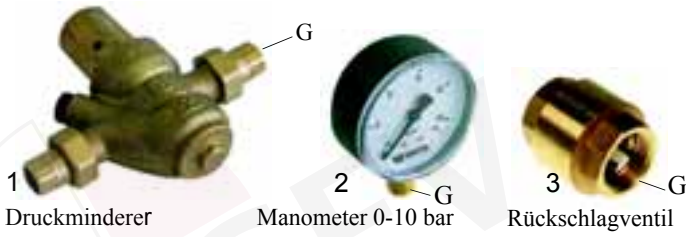

Pos.	Bestell-Nr.	G	Pos.	Bestell-Nr.	G
1	520265	1/2"	3	520273	1/2"
1	520266	3/4"	3	520274	3/4"
2	520270	1/4"			

Schmutzfänger MS

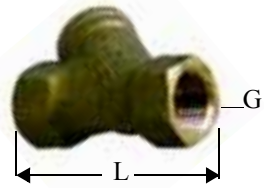

Pos.	Best.-Nr.	G	L/mm	Pos.	Best.-Nr.	G	L/mm
1	520260	3/8"	65	4	520263	1"	90
2	520261	1/2"	65	5	520264	1 1/4"	110
3	520262	3/4"	75				

Schmutzfänger PVC mit CNS Sieb



Abb. Nr.	Best.-Nr.	NW	G	L/mm	Abb. Nr.	Best.-Nr.	NW	G	L/mm
1	520128	17	3/4"	95	3	510836	17	3/4"	77
2	520129	10	3/4"	87					

Zubehör für Anschlusschläuche



Abb. Nr.	Best.-Nr.	VPE	in mm D1	in mm D2	Abb. Nr.	Best.-Nr.	VPE	in mm D1	in mm D2
1	520056	5	11	24	2	520058	5	11	24
1	520057	5	13	24	2	520059	5	13	24



Abb. Nr.	Best.-Nr.	VPE	D/mm	G	Abb. Nr.	Best.-Nr.	VPE	G
1	520050	1	10	3/4"	3	520052	1	3/4"
2	520051	1	-	3/4"				

Doppelnippel/ Dichtung

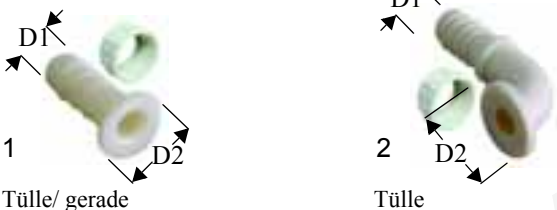

Abb. Nr.	Best.-Nr.	VPE	G	Abb. Nr.	Best.-Nr.	VPE	G
1	520063	5	1/2"	3	521138	10	3/8"
1	520064	5	3/4"	3	520055	10	1/2"
2	520053	10	3/4"	3	520054	10	3/4"

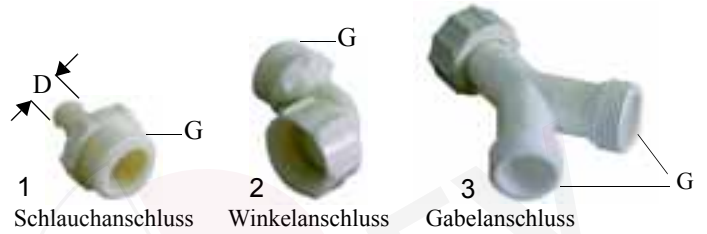
Schlauchschellen CNS



Abb. Nr.	Best.-Nr.	VPE	Bereich (mm)	Abb. Nr.	Best.-Nr.	VPE	Bereich (mm)
1	520110	10	8 - 12	1	520116	5	32 - 50
1	520111	10	10 - 16	1	520117	5	40 - 60
1	520112	10	12 - 20	1	520118	5	50 - 70
1	520113	10	16 - 25	1	520119	5	60 - 80
1	520114	10	20 - 32	2	520120	1	12 - 20
1	520115	10	25 - 40	2	520121	1	16 - 25

Schlauchschellen UNEX



Abb. Nr.	Best.-Nr.	VPE	Bereich (mm)	Abb. Nr.	Best.-Nr.	VPE	Bereich (mm)
1	520065	5	5 - 10	2	520084	1	5 - 10
1	520066	5	7 - 12	2	520078	1	7 - 12
1	520067	5	9 - 14	2	520079	1	9 - 14
1	520068	5	12 - 17	2	520080	1	12 - 17
1	520069	5	14 - 19	2	520081	1	14 - 19
1	520070	5	16 - 21	2	520082	1	16 - 21
1	520071	5	17 - 22	2	520083	1	17 - 22
1	520073	5	20 - 25	2	520085	1	20 - 25
1	520074	5	22 - 27	2	520086	1	22 - 27
1	520075	5	24 - 29	2	520087	1	24 - 29
1	520076	5	25 - 30	2	520088	1	25 - 30
1	520077	5	28 - 33	2	520089	1	28 - 33

Schlauchschellen-Band/Schloss



Abb. Bestell-Nr.

1 520127

EASY-ROLL Sortiment, Material V2A

bestehend aus: 4,5 m Uni-Spannband und 12 St. Spannschlösser



1 Spannschloss CNS
Schraube verzinkt

2 Spannband
Breite: 8mm

3 Spannschloss

Abb.	Best.-Nr.	VPE	Breite (mm)	Abb.	Best.-Nr.	VPE	Breite (mm)
1	520123			3	515080	10St.	
2	520122	5m	8				

Ablaufschläuche



Pos.	Bestell-Nr.	Maße in mm		
		L	G	D
1	515081	400	1 1/2"	40
2	515082	750	1 1/2"	40

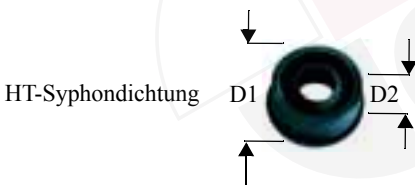

HT-Syphondichtung

Pos.	Best.-Nr.	Maße in mm		Pos.	Best.-Nr.	Maße in mm	
		D1	D2			D1	D2
1	515083	50	40	3	515085	40	25-32
2	515084	50	25-32				

Ablaufschlauch und Anschlussstücke



Abb.	Bestell-Nr.	VPE	Bezeichnung	D
1	515070	1	Schlauch flexibel (3-5,5m)	30



Abb.	Bestell-Nr.	VPE	Bezeichnung	D
2	515074	4	Anschlußstück gerade	32
2	515075	4	Anschlußstück gerade	36,5
2	515076	4	Anschlußstück gerade	40
3	515079	4	Anschlußstück gewinkelt	32

Abb.	Bestell-Nr.	VPE	Bezeichnung	G
4	515071	4	Anschlußstück gerade	1"
4	515072	4	Anschlußstück gerade	1 1/4"
4	515073	4	Anschlußstück gerade	1 1/2"
5	515077	4	Anschlußstück gewinkelt	1 1/4"
5	515078	4	Anschlußstück gewinkelt	1 1/2"

Ablaufsysteme

Technische Daten:

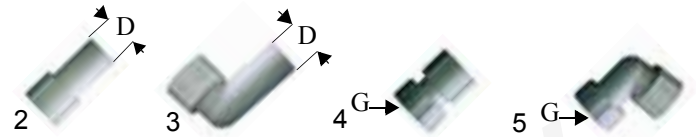
Syphon aus PP weiß
mit Geräteablaufanschluß



Abb.	Best.-Nr.	G	D/mm	Abb.	Best.-Nr.	G	D/mm
1	515001	1 1/2"	40 - 50	2	515008	1 1/2"	40
				2	515009	1 1/2"	50

Technische Daten:

Doppel-Syphon aus PP
weiß
mit Geräteablaufanschluß

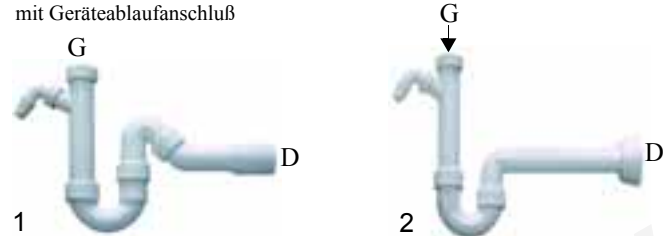

Abb.	Bestell-Nr.	G	L in mm	D in mm
1	515004	1 1/2"	250-260	40
1	515005	1 1/2"	250-260	50
2	515002	1 1/2"	max.260	40
2	515003	1 1/2"	max.260	50

Ablaufsysteme

Zwischenstücke

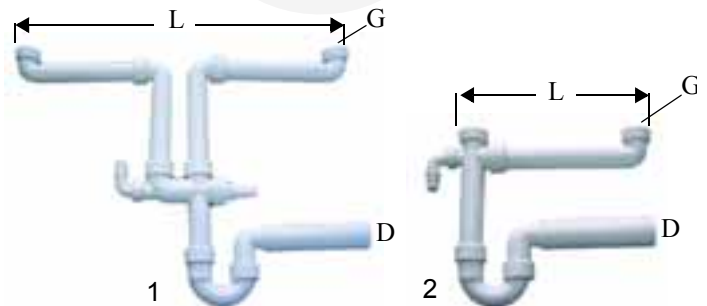

Pos.	Bestell-Nr.	L/mm	H/mm	G1	G2	D/mm
1	515011	160mm	80mm	1 1/2"	-	40



Abb.	Bestell-Nr.	G	L/mm	D/mm
1	515012	1 1/2"	200	40
2	515013	1 1/2"	160	40
3	515014	1 1/2"	100	40

Geräteanschlüsse

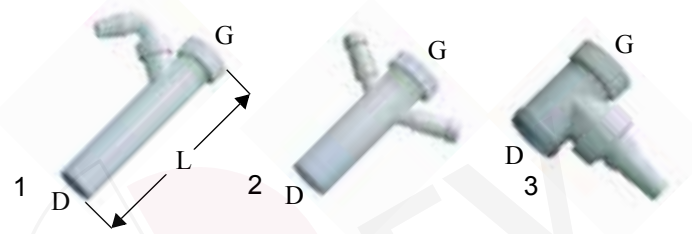

Abb.	Best.-Nr	G	D/mm	Abb.	Best.-Nr.	G	D/mm
1	520045	1"	20	2	520044	1"	20

Ablaufventilreduzierung

Pos.	Bestell-Nr.	IG	AG	Abb.	Bestell-Nr.	IG	AG
1	515101	1"	1/4"	3	515103	1/2"	1/4"
2	515102	1/4"	1"	4	515104	2"	1/2"



Abb.	Bestell-Nr.	G	D/mm	Abb.	Bestell-Nr.	G	D/mm
1	515015	1 1/2"	40	3	515032	-	40
2	515010	1 1/2"	-				

Biomatic-Dosiergerät

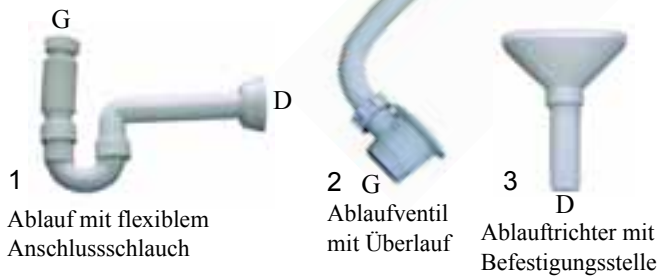

Technische Daten:

Das Dosiergerät für biologische Produkte entfernt Verkrustungen, Verstopfungen, Fettablagerungen und schlechten Geruch in Abflussrohren.

Automatischer Ablauf 3mal täglich; Einspritzzeit zwischen 30 sec und 3 min; programmierbar, automatische Reduzierung der Dosierung nach 30 Tagen Betrieb.

Pos.	Bestell-Nr.	Anschluss	Pumpleistung	SchlauchTyp	Größe
1	361530	230V AC	3l/h	Santopren	4x6mm

O-Ringe - EPDM

Ø 1,78 mm

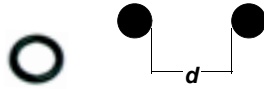

Pos.	Bestell-Nr. 1 Stck.	10 Stck.	d/mm	Pos.	Bestell-Nr. 1 Stck.	10 Stck.	d/mm	Pos.	Bestell-Nr. 1 Stck.	10 Stck.	d/mm	Pos.	Bestell-Nr. 1 Stck.	10 Stck.	d/mm
1		532001	1,78	14	510302	511505	12,42	27		532021	33,05	40		532034	72,75
2	511614	532002	2,78	15	518061	532009	14,00	28		532022	34,65	41		532035	75,92
3		511500	2,90	16	530284	532010	15,60	29		532023	37,82	42		532036	82,27
4	501283	532003	3,69	17	510322	532011	17,17	30	510900	532024	41,00	43		532037	88,62
5	530288	511501	4,48	18		532012	18,77	31		532025	44,17	44		532038	94,97
6	505045	532004	5,28	19	510824	532013	20,35	32		532026	47,35	45		532039	101,32
7	528485	511502	6,07	20	517045	532014	21,95	33		532027	50,52	46		532040	107,67
8	510303	532005	6,75	21	516167	532015	23,52	34		532028	53,70	47		532041	114,02
9	510177	511503	7,66	22	508084	532016	25,12	35		532029	56,87	48	511130	532042	120,37
10	511018	532006	8,73	23		532017	26,70	36		532030	60,05	49		532043	126,72
11	510055	511504	9,25	24	513057	532018	28,30	37		532031	63,22	50		532044	133,07
12	505176	532007	10,82	25		532019	29,87	38		532032	66,40				
13	524060	532008	11,11	26		532020	31,47	39		532033	69,57				

Ø 2,62 mm

Pos.	Bestell-Nr. 1 Stck.	10 Stck.	d/mm	Pos.	Bestell-Nr. 1 Stck.	10 Stck.	d/mm	Pos.	Bestell-Nr. 1 Stck.	10 Stck.	d/mm	Pos.	Bestell-Nr. 1 Stck.	10 Stck.	d/mm
1		532045	5,23	17	507310	511512	18,72	33	505192	532068	39,34	49		532084	64,77
2	518275	532046	6,02	18	518491	511513	20,24	34	528339	532069	40,95	50		532085	66,35
3	529544	532047	7,59	19	507311	532055	20,63	35	524161	532070	42,52	51		532086	67,95
4	510903	532048	9,13	20	532453	511514	21,89	36		532071	44,12	52		532087	69,52
5	504107	511506	9,19	21	512071	532056	22,22	37	512111	532072	45,69	53	528232	532088	71,12
6	510893	532049	9,92	22		532057	23,47	38	507317	532073	47,30	54		532089	72,69
7	510077	511507	10,78	23		532058	23,81	39		532074	48,89	55	528800	532090	75,87
8	508016	532050	11,91	24	510769	532059	25,07	40	512056	532075	50,47	56		532091	82,22
9	528110	511508	12,37	25		532060	26,65	41		532076	52,07	57	512235	532092	88,57
10	510892	532051	13,10	26	511287	532061	28,25	42		532077	53,65	58		532093	94,92
11	507313	511509	13,95	27	504561	532062	29,82	43	512114	532078	55,25	59		532094	101,27
12	528206	532052	15,08	28	517104	532063	31,42	44		532079	56,82	60		532095	107,62
13	518349	511510	15,54	29	507314	532064	32,99	45	510974	532080	58,42	61		532096	113,97
14	508008	532053	15,88	30	517122	532065	34,60	46	504577	532081	60,00	62		532097	120,32
15	507309	511511	17,13	31		532066	36,14	47		532082	61,60	63		532098	126,67
16	516026	532054	17,86	32		532067	37,77	48		532083	63,17	64		532099	133,02

Ø 3,53 mm

Pos.	Bestell-Nr. 1 Stck.	10 Stck.	d/mm	Pos.	Bestell-Nr. 1 Stck.	10 Stck.	d/mm	Pos.	Bestell-Nr. 1 Stck.	10 Stck.	d/mm	Pos.	Bestell-Nr. 1 Stck.	10 Stck.	d/mm
1		532100	7,51	20		511527	37,69	39	528793	532121	58,74	58	532457	532140	85,32
2		532101	9,12	21	516202	532107	39,69	40	524153	532122	59,92	59		532141	88,50
3		532102	12,29	22	524148	511528	40,86	41		532123	60,33	60		532142	91,67
4		532103	13,87	23	504122	532108	41,28	42		532124	61,91	61	504609	532143	94,84
5		532104	15,47	24	508061	532109	42,86	43	511267	532125	63,09	62		532144	98,02
6		532105	17,04	25		511529	44,04	44		532126	63,50	63	510009	532145	101,20
7	510951	511515	18,64	26		532110	44,45	45		532127	65,09	64		532146	104,40
8	508204	511516	20,22	27		532111	46,04	46	528902	532128	66,27	65		532147	107,50
9		511517	21,82	28	505180	511530	47,22	47		532129	66,68	66	511339	532148	110,70
10	517087	511518	23,40	29	524166	532112	47,63	48		532130	68,26	67		532149	113,90
11		511519	24,99	30	528175	532113	49,21	49		532131	69,44	68		532150	117,10
12		532106	25,80	31		511531	50,39	50		532132	69,85	69		532151	120,20
13		511520	26,58	32		532114	50,80	51		532133	71,44	70		532152	123,40
14		511521	28,17	33		532115	52,39	52		532134	72,62	71		532153	126,60
15	524128	511522	29,75	34	519185	532116	53,57	53	504580	532135	73,03	72		532154	129,80
16	528412	511523	31,34	35	532451	532117	53,98	54		532136	74,61	73	510525		169,70
17	519177	511524	32,93	36	532502	532118	55,56	55		532137	75,80	74	511134		169,70
18	510895	511525	34,52	37	510891	532119	56,74	56		532138	78,97	75	510896		183,75
19		511526	36,10	38		532120	57,15	57		532139	82,14	76	540525		167,70

O-Ringe - EPDM

Ø 5,34 mm

Pos.	Bestell-Nr. 1 Stck. 10 Stck.	d/mm	Pos.	Bestell-Nr. 1 Stck. 10 Stck.	d/mm	Pos.	Bestell-Nr. 1 Stck. 10 Stck.	d/mm	Pos.	Bestell-Nr. 1 Stck. 10 Stck.	d/mm
1	519283 532155	37,47	9	691033 532163	62,87	17	510447 532171	81,92	25	532179	101,00
2	532156	40,65	10	532164	66,04	18	505178 532172	85,09	26	532180	104,10
3	505092 532157	43,82	11	508109 532165	69,22	19	532173	88,27	27	532181	107,32
4	508148 532158	47,00	12	532166	72,39	20	532174	89,69	28	532182	109,50
5	505175 532159	50,16	13	532167	74,63	21	532175	91,44	29	508032 532183	110,50
6	532160	53,34	14	510410 532168	75,57	22	532176	94,62	30	532184	113,70
7	519318 532161	56,52	15	532169	78,74	23	532177	97,79	31	532185	117,50
8	529460 532162	59,69	16	532170	79,77	24	532178	100,00	32	508129	139,70

O-Ringe - Silikon

Ø 1,78 mm

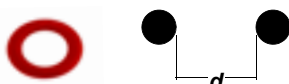

Pos.	Bestell-Nr. 1 Stck. 10 Stck.	d/mm	Pos.	Bestell-Nr. 1 Stck. 10 Stck.	d/mm	Pos.	Bestell-Nr. 1 Stck. 10 Stck.	d/mm	Pos.	Bestell-Nr. 1 Stck. 10 Stck.	d/mm
1	532186	1,78	14	532199	12,42	27	532505 532212	33,05	40	532225	72,75
2	532187	2,78	15	530315 532200	14,00	28	532213	34,65	41	532226	75,92
3	532188	2,90	16	532201	15,60	29	532214	37,82	42	532227	82,27
4	532189	3,69	17	530311 532202	17,17	30	532215	41,00	43	532228	88,62
5	532190	4,48	18	532203	18,77	31	532216	44,17	44	532229	94,97
6	532191	5,28	19	532204	20,35	32	532217	47,35	45	532230	101,32
7	371100 532192	6,07	20	532205	21,95	33	532218	50,52	46	532231	107,67
8	532508 532193	6,75	21	532206	23,52	34	532219	53,70	47	532232	114,02
9	532194	7,66	22	532207	25,12	35	532220	56,87	48	532233	120,37
10	532195	8,73	23	532208	26,70	36	532221	60,05	49	532234	126,72
11	532196	9,25	24	532209	28,30	37	532222	63,22	50	532235	133,07
12	532197	10,82	25	532210	29,87	38	532223	66,40			
13	529422 532198	11,11	26	532211	31,47	39	532224	69,57			

Ø 2,62 mm

Pos.	Bestell-Nr. 1 Stck. 10 Stck.	d/mm	Pos.	Bestell-Nr. 1 Stck. 10 Stck.	d/mm	Pos.	Bestell-Nr. 1 Stck. 10 Stck.	d/mm	Pos.	Bestell-Nr. 1 Stck. 10 Stck.	d/mm
1	532236	5,23	17	532252	18,72	33	532268	39,34	49	532284	64,77
2	532237	6,02	18	528692 532253	20,24	34	532269	40,95	50	532285	66,35
3	532238	7,59	19	532254	20,63	35	532270	42,52	51	532286	67,95
4	532239	9,13	20	532255	21,89	36	532271	44,12	52	532287	69,52
5	532240	9,19	21	532256	22,22	37	532272	45,69	53	532288	71,12
6	532241	9,92	22	532257	23,47	38	532273	47,30	54	532289	72,69
7	528222 532242	10,78	23	532258	23,81	39	532274	48,89	55	532290	75,87
8	532243	11,91	24	532259	25,07	40	532275	50,47	56	532291	82,22
9	532244	12,37	25	532260	26,65	41	532276	52,07	57	532292	88,57
10	529187 532245	13,10	26	532261	28,25	42	532277	53,65	58	532293	94,92
11	532246	13,95	27	532262	29,82	43	532278	55,25	59	532294	101,27
12	532247	15,08	28	532263	31,42	44	532279	56,82	60	532295	107,62
13	532248	15,54	29	532264	32,99	45	532280	58,42	61	532296	113,97
14	532249	15,88	30	532265	34,60	46	532281	60,00	62	532297	120,32
15	532250	17,13	31	532266	36,14	47	532282	61,60	63	532298	126,67
16	532251	17,86	32	532267	37,77	48	532283	63,17	64	532299	133,02

2

Universalteile/ Mechanik

O-Ringe - Silikon

Ø 3,53 mm

Pos.	Bestell-Nr. 1 Stck. 10 Stck.	d/mm	Pos.	Bestell-Nr. 1 Stck. 10 Stck.	d/mm	Pos.	Bestell-Nr. 1 Stck. 10 Stck.	d/mm	Pos.	Bestell-Nr. 1 Stck. 10 Stck.	d/mm		
1	532300	7,51	19	532318	36,10	37	532336	56,74	55	532354	75,80		
2	532301	9,12	20	532319	37,69	38	532337	57,15	56	532455	532355	78,97	
3	532302	12,29	21	532320	39,69	39	532338	58,74	57	532356	82,14		
4	532303	13,87	22	104264	532321	40,86	40	529362	532339	59,92	58	532357	85,32
5	532304	15,47	23	532322	41,28	41	532340	60,33	59	532358	88,50		
6	532305	17,04	24	532323	42,86	42	532341	61,91	60	532359	91,67		
7	532306	18,64	25	532324	44,04	43	532342	63,09	61	532360	94,84		
8	532307	20,22	26	532325	44,45	44	528679	532343	63,50	62	532361	98,02	
9	532308	21,82	27	532326	46,04	45	532344	65,09	63	532454	532362	101,20	
10	532309	23,40	28	532327	47,22	46	528182	532345	66,27	64	532363	104,40	
11	532310	24,99	29	532328	47,63	47	532346	66,68	65	532364	107,50		
12	532311	25,80	30	514021	532329	49,21	48	532347	68,26	66	532365	110,70	
13	532312	26,58	31	528948	532330	50,39	49	532348	69,44	67	532366	113,90	
14	532313	28,17	32	532331	50,80	50	532349	69,85	68	532367	117,10		
15	532314	29,75	33	532332	52,39	51	532350	71,44	69	532368	120,20		
16	532315	31,34	34	532333	53,57	52	532351	72,62	70	532369	123,40		
17	532316	32,93	35	532334	53,98	53	532352	73,03	71	532370	126,60		
18	530026	532317	34,52	36	532335	55,56	54	532507	532353	74,61	72	532371	129,80

Ø 5,34 mm

Pos.	Bestell-Nr. 1 Stck. 10 Stck.	d/mm	Pos.	Bestell-Nr. 1 Stck. 10 Stck.	d/mm	Pos.	Bestell-Nr. 1 Stck. 10 Stck.	d/mm	Pos.	Bestell-Nr. 1 Stck. 10 Stck.	d/mm	
1	532372	37,47	9	532380	62,87	17	532388	81,92	25	532396	101,00	
2	532373	40,65	10	532381	66,04	18	532389	85,09	26	532397	104,10	
3	532374	43,82	11	532382	69,22	19	532390	88,27	27	532398	107,32	
4	510562	532375	47,00	12	532383	72,39	20	532391	89,69	28	532399	109,50
5	532376	50,16	13	532384	74,63	21	532392	91,44	29	532400	110,50	
6	532377	53,34	14	532385	75,57	22	532393	94,62	30	532401	113,70	
7	532378	56,52	15	532386	78,74	23	532394	97,79	31	532402	117,50	
8	532379	59,69	16	532387	79,77	24	532395	100,00				

O-Ringe - Viton

Ø 1,78 mm

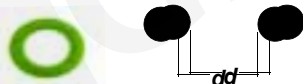

Pos.	Bestell-Nr. 1 Stck. 10 Stck.	d/mm	Pos.	Bestell-Nr. 1 Stck. 10 Stck.	d/mm	Pos.	Bestell-Nr. 1 Stck. 10 Stck.	d/mm	Pos.	Bestell-Nr. 1 Stck. 10 Stck.	d/mm			
1	532403	1,78	6	532408	5,28	11	532413	9,25	16	532418	15,60			
2	532404	2,78	7	371095	532409	6,07	12	532414	10,82	17	532419	17,17		
3	528347	532405	2,90	8	101527	532410	6,75	13	528833	532415	11,11	18	532420	18,77
4	528687	532406	3,69	9	528282	532411	7,66	14	528607	532416	12,42	19	532421	20,35
5	101526	532407	4,48	10	528246	532412	8,73	15	532417	14,00	20	532452	532422	21,95

Ø 2,62 mm

Pos.	Bestell-Nr. 1 Stck. 10 Stck.	d/mm	Pos.	Bestell-Nr. 1 Stck. 10 Stck.	d/mm	Pos.	Bestell-Nr. 1 Stck. 10 Stck.	d/mm	Pos.	Bestell-Nr. 1 Stck. 10 Stck.	d/mm			
1	532423	5,23	6	528226	532428	9,92	11	532433	13,95	16	532438	17,86		
2	532424	6,02	7	528211	532429	10,78	12	528251	532434	15,08	17	528455	532439	18,72
3	532425	7,59	8	528291	532430	11,91	13	532435	15,54	18	532504	532440	20,24	
4	528350	532426	9,13	9	528231	532431	12,37	14	528293	532436	15,88	19	532441	20,63
5	532427	9,19	10	532432	13,10	15	532437	17,13	20	528278	25,07	21	529190	31,42

Ø 3,53 mm

Pos.	Bestell-Nr. 1 Stck. 10 Stck.	d/mm	Pos.	Bestell-Nr. 1 Stck. 10 Stck.	d/mm	Pos.	Bestell-Nr. 1 Stck. 10 Stck.	d/mm	Pos.	Bestell-Nr. 1 Stck. 10 Stck.	d/mm	
1	532442	7,51	5	532446	15,47	9	528155	32,93	13	510246	55,56	
2	532443	9,12	6	532447	17,04	10	532450	47,22	14	105264	94,84	
3	532444	12,29	7	532448	18,64	11	529186	47,63				
4	532445	13,87	8	514222	532449	20,22	12	510245	50,80			

Stahldrahtkörbe/ rund



Pos.	Bestell-Nr.	Ø	Höhe	Passend für
1	970308	360mm	140mm	
2	970309	360mm	170mm	
3	970310	360mm	230mm	
4	970311	410mm	140mm	Adler
5	970312	410mm	170mm	Hoonved
6	970313	410mm	230mm	Rancilio
7	970314	450mm	140mm	Luxia
8	970315	450mm	170mm	
9	970316	450mm	230mm	



Abb.	Bestell-Nr.	Ø	Höhe	Passend für
1	970317	350mm	110mm	Dühr
1	970318	400mm	140mm	Dühr
2	970319	380mm	160mm	Comenda



Pos.	Bestell-Nr.	Ø	Höhe	Passend für
1	970325	350mm	110mm	
1	970326	350mm	170mm	
1	970320	370mm	170mm	Elettrobar
1	970321	370mm	190mm	
1	970322	400mm	190mm	
2	970323	370mm	150mm	Ata
2	970324	390mm	170mm	

Stahldrahtkörbe 345x345mm



Pos.	Bestell-Nr.	Beschreibung	Höhe
1	971006	Universalkorb/ feinmaschig	120mm

Stahldrahtkörbe 350x350mm



Abb.	Bestell-Nr.	Beschreibung	Höhe
1	971001	Universalkorb/ grobmaschig	120mm
1	971002	Universalkorb/ grobmaschig	180mm
1	971003	Universalkorb/ feinmaschig	130mm
2	971004	Gläserkorb, 3-reihig, schräger Boden	170mm
2	971005	Gläserkorb, 4-reihig, schräger Boden	170mm

Stahldrahtkörbe 370x370mm



ohne
Abbildung!
3

Abb.	Bestell-Nr.	Beschreibung	Höhe
1	971007	Universalkorb	135mm
2	971008	Gläserkorb, 3-reihig, schräger Boden	180mm
3	971009	Tellerkorb, 10 Teller	100mm

Stahldrahtkörbe 375x375mm



Abb.	Bestell-Nr.	Beschreibung	Höhe
1	971010	Universalkorb	140mm
1	971011	Universalkorb	170mm
2	971012	Gläserkorb, 3-reihig, schräger Boden	175mm

Stahldrahtkörbe 382x382mm



Abb.	Bestell-Nr.	Beschreibung	Höhe
1	971013	Universalkorb/ grobmaschig	90mm
1	971014	Universalkorb/ grobmaschig	170mm
1	971015	Universalkorb/ grobmaschig	200mm
2	971016	Universalkorb/ feinmaschig	130mm
3	971017	Gläserkorb, 3-reihig, schräger Boden	170mm
3	971018	Gläserkorb, 4-reihig, schräger Boden	170mm
3	971019	Gläserkorb, 4-reihig, gerade Boden	170mm

Stahldrahtkörbe 450x450mm



Abb.	Bestell-Nr.	Beschreibung	Höhe
1	971029	Universalkorb/ grobmaschig	120mm
1	971030	Universalkorb/ grobmaschig	170mm
2	971031	Universalkorb/ feinmaschig	130mm

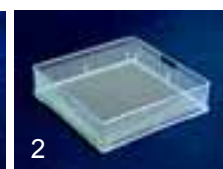

Abb.	Bestell-Nr.	Beschreibung	Höhe
1	971032	Tellerkorb (14 Teller)	105mm
2	971033	Gläserkorb, 4-reihig, schräger Boden	170mm
2	971034	Gläserkorb, 5-reihig, schräger Boden	170mm

Stahldrahtkörbe 460x460mm

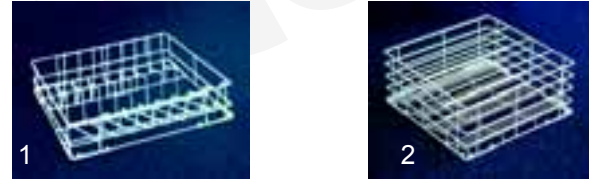

Abb.	Bestell-Nr.	Beschreibung	Höhe
1	971049	Universalkorb	
1	971050	Universalkorb/ feinmaschig	135mm
2	971051	Tellerkorb (16 Teller)	100mm
3	971052	Gläserkorb, schräger Boden	

Stahldrahtkörbe 500x430mm

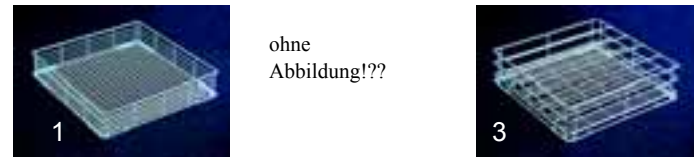

Abb.	Bestell-Nr.	Beschreibung	Höhe
1	971035	Universalkorb/ grobmaschig	170mm
1	971036	Universalkorb/ feinmaschig	150mm
2	971037	Tellerkorb, 6-reihig	95mm
2	971038	Tellerkorb, 8-reihig	95mm
3	971039	Gläserkorb, 3-reihig, schräger Boden	170mm
3	971040	Gläserkorb, 4-reihig, schräger Boden	170mm
3	971041	Gläserkorb, 5-reihig, schräger Boden	170mm

Stahldrahtkörbe 500x450mm



Abb.	Bestell-Nr.	Beschreibung	Höhe
1	971047	Universalkorb	120mm
2	971048	Tellerkorb (16 Teller)	95mm
3	971042	Gläserkorb, 4-reihig, schräger Boden	170mm



Abb.	Bestell-Nr.	Beschreibung	Höhe
1	971020	Tassenkorb, schräger Boden	125mm
2	971021	Tellerkorb (Teller-Ø 130mm)	80mm
3	971022	Tellerkorb (Teller-Ø 240mm)	120mm

Stahldrahtkörbe 400x400mm



Abb.	Bestell-Nr.	Beschreibung	Höhe
1	970067	Universalkorb/ grobmaschig	105mm
1	970068	Universalkorb/ grobmaschig	170mm
2	971023	Universalkorb/ feinmaschig	130mm
3	970069	Tellerkorb	110mm

Stahldrahtkörbe 400x400mm

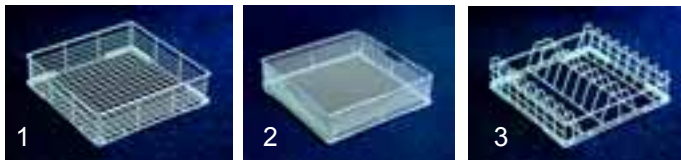

Abb.	Bestell-Nr.	Beschreibung	Höhe
1	970070	Kombikorb	85mm
2	971024	Gläserkorb, 3-reihig, schräger Boden	170mm
2	970065	Gläserkorb, 4-reihig, schräger Boden	170mm
2	970066	Gläserkorb, 4-reihig, schräger Boden	200mm

Stahldrahtkörbe 420x420mm



Abb.	Bestell-Nr.	Beschreibung	Höhe
1	971025	Universalkorb	150mm
2	971026	Tellerkorb (10 Teller)	120mm

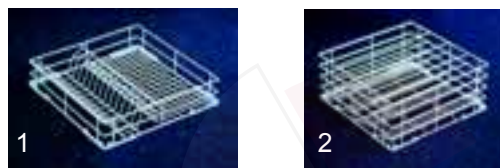

Abb.	Bestell-Nr.	Beschreibung	Höhe
1	971027	Tellerkorb (12 Teller)	105mm
2	971028	Gläserkorb, 4-reihig, schräger Boden	170mm

Stahldrahtkörbe 500x500mm



Abb.	Bestell-Nr.	Beschreibung	Höhe
1	970072	Universalkorb/ grobmaschig	105mm
1	970073	Universalkorb/ grobmaschig	205mm
2	970074	Universalkorb/ feinmaschig	125mm



Abb.	Bestell-Nr.	Beschreibung	Höhe
1	970071	Tellerkorb (18 Teller/ Ø240mm)	95mm
1	971043	Tellerkorb (20 Teller)	130mm
2	971044	Pizzatellerkorb (12 Teller/ Ø290mm)	130mm

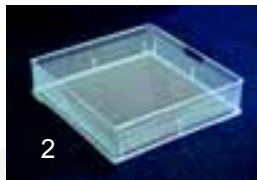

Abb.	Bestell-Nr.	Beschreibung	Höhe
1	971045	Tellerkorb, 7-reihig	130mm
1	971046	Tellerkorb, 9-reihig	130mm
2	970075	Gläserkorb, 5-reihig, schräger Boden	140mm
2	970076	Gläserkorb, 5-reihig, schräger Boden	195mm

Stahldrahtkörbe 540x540mm



Pos.	Bestell-Nr.	Beschreibung	Höhe
1	971053	Tellerkorb (22 Teller/ Ø240mm)	

Stahldrahtkörbe 550x550mm



Abb.	Bestell-Nr.	Beschreibung	Höhe
1	971054	Universalkorb/ grobmaschig	120mm
1	971055	Universalkorb/ grobmaschig	170mm
1	970027	Universalkorb/ feinmaschig	130mm
2	970026	Tellerkorb (24 Teller)	

Kunststoffkörbe 350x350mm



Pos.	Bestell-Nr.	Beschreibung	Höhe
1	971058	Universalkorb	160mm

Kunststoffkörbe 385x385mm



Abb.	Bestell-Nr.	Beschreibung	Höhe
1	971060	Universalkorb	65mm
1	971061	Universalkorb	120mm
1	971062	Universalkorb	180mm
2	971063	Gläserkorb, 3 x 3 (112)	170mm
2	971081	Gläserkorb, 3 x 3 (112)	230mm
2	971082	Gläserkorb, 3 x 3 (112)	260mm



Abb.	Bestell-Nr.	Beschreibung	Höhe
1	971064	Gläserkorb, 4 x 4 (82)	170mm
1	971083	Gläserkorb, 4 x 4 (82)	230mm
1	971084	Gläserkorb, 4 x 4 (82)	260mm
2	971085	Gläserkorb, 5 x 5 (63)	170mm
2	971086	Gläserkorb, 5 x 5 (63)	230mm
2	971087	Gläserkorb, 5 x 5 (63)	260mm

Kunststoffkörbe 400x400mm

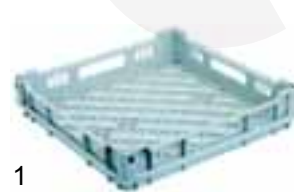

Abb.	Bestell-Nr.	Beschreibung	Höhe
1	971065	Universalkorb	65mm
1	971066	Universalkorb	170mm
1	971067	Universalkorb	230mm
1	971068	Universalkorb	260mm
2	971069	Gläserkorb, 3 x 3 (112)	170mm
2	971070	Gläserkorb, 3 x 3 (112)	230mm
2	971071	Gläserkorb, 3 x 3 (112)	260mm



Abb.	Bestell-Nr.	Beschreibung	Höhe
1	971072	Gläserkorb, 4 x 4 (82)	170mm
1	971073	Gläserkorb, 4 x 4 (82)	230mm
1	971074	Gläserkorb, 4 x 4 (82)	206mm
2	971075	Gläserkorb, 5 x 5 (63)	170mm
2	971076	Gläserkorb, 5 x 5 (63)	230mm
2	971077	Gläserkorb, 5 x 5 (63)	260mm



Abb.	Bestell-Nr.	Beschreibung	Höhe
1	971078	Universalkorb	160mm
2	971079	Tellereinsatz	
3	971080	Gläserinsatz	



Abb.	Bestell-Nr.	Beschreibung	Höhe
1	970040	Universalkorb	110mm
2	970048	Gläserinsatz	
3	970043	Gläserinsatz, 4-reihig	



Abb.	Bestell-Nr.	Beschreibung	Höhe
1	970045	Tellerkorb	110mm
2	970041	Gläserkorb	130mm

Zubehör



-Gläserinsatz für Körbe
-Max 400x400mm (kürzbar)

Abb.	Bestell-Nr.	Beschreibung
1	970302	10 Einteiler



Abb.	Bestell-Nr.	Beschreibung	Länge
1	970047	Tellereinsatz	300mm
1	970044	Tellereinsatz	355mm
1	970061	Tellereinsatz	430mm
2	970349	Besteckeinsatz, 130x55x100mm	
3	970064	Besteckeinsatz, 160x160x110mm	



Abb.	Bestell-Nr.	Beschreibung
1	976016	Besteckeinsatz, 110x110mm
2	976011	Besteckeinsatz, rund



Pos.	Bestell-Nr.	Beschreibung
1	970001	Gleitecke für Drahtkörbe

Kunststoffkörbe 500x500mm



Abb.	Bestell-Nr.	Beschreibung	Höhe
1	972001	Universalkorb/ grobmaschig	101mm
2	972002	Universalkorb/ feinmaschig	101mm
3	972003	Tellerkorb, 12 bis 18	101mm



Abb.	Bestell-Nr.	Beschreibung	Höhe
1	972004	Tassenkorb (16 Tassen)	101mm
1	972005	Tassenkorb (20 Tassen)	101mm
2	972030	Tablettkorb	101mm

Gläserkorb (9 Fächer) 148mmx148mm



Pos.	B.-Nr.	Höhe Gesamt	Höhe Nutz	Pos.	B.-Nr.	Höhe Gesamt	Höhe Nutz
1	972010	102mm	81mm	4	972042	219mm	198mm
2	972040	141mm	120mm	5	972043	258mm	237mm
3	972041	180mm	159mm	6	972044	297mm	276mm

Gläserkorb (16 Fächer) 113mmx113mm



Pos.	B.-Nr.	Höhe Gesamt	Höhe Nutz	Pos.	B.-Nr.	Höhe Gesamt	Höhe Nutz
1	972008	102mm	81mm	3	972047	219mm	198mm
2	972045	141mm	120mm	4	972048	258mm	237mm
3	972046	180mm	159mm	5	972049	297mm	276mm

Gläserkorb (25 Fächer) 89mmx89mm



Pos.	B.-Nr.	Höhe Gesamt	Höhe Nutz	Pos.	B.-Nr.	Höhe Gesamt	Höhe Nutz
1	972006	102mm	81mm	4	972052	219mm	198mm
2	972050	141mm	120mm	5	972053	258mm	237mm
3	972051	180mm	159mm	6	972054	297mm	276mm

Gläserkorb (36 Fächer) 74mmx74mm



Pos.	B.-Nr.	Höhe Gesamt	Höhe Nutz	Pos.	B.-Nr.	Höhe Gesamt	Höhe Nutz
1	972007	81mm		4	972057	198mm	
2	972055	120mm		5	972058	237mm	
3	972056	159mm		6	972059	276mm	

Gläserkorb (49 Fächer) 65mmx65mm



Pos.	B.-Nr.	Höhe Gesamt	Höhe Nutz	Pos.	B.-Nr.	Höhe Gesamt	Höhe Nutz
1	972009	81mm		4	972062	198mm	
2	972060	120mm		5	972063	237mm	
3	972061	159mm		6	972064	276mm	

Aufsatzringe



Pos.	Bestell-Nr.	Fächer	Höhe Gesamt	Höhe Nutz
1	972020	ohne	44	39
2	972025	9	44	39
3	972023	16	44	39
4	972021	25	44	39
5	972022	36	44	39
6	972024	49	44	39

Zubehör



Abb.	Bestell-Nr.	Beschreibung
1	972013	Rollwagen ohne Griff
2	972018	Rollwagen mit Griff
3	972031	Staubschutzhaube, 915mm Höhe
3	972033	Staubschutzhaube, 1219mm Höhe
4	972034	Korbabdeckung (ohne Bild)

Diverses



Abb.	Bestell-Nr.	Beschreibung	Maße in mm
1	972032	Besteckkorb ohne Griff	
2	972012	Besteckkorb mit Griff	429 x 206 x 149
3	972011	Besteckkorbeinsatz	
4	975015	Besteckkasten	

Kunststoffkörbe 500x500 mm

Außen geschlossen



Abb.	Bestell-Nr.	Beschreibung	Höhe	
			Gesamt	Nutz
1	976001	Universalkorb großmaschig	100	80
2	976002	Universalkorb feinmaschig	100	80



Abb.	Bestell-Nr.	Beschreibung	Höhe	
			Gesamt	Nutz
1	976003	Tellerkorb 14/18 Teller	100	--
2	976030	Tablettkorb 9 Tablett	100	--

Aufsatzringe/Deckel



Abb.	Bestell-Nr.	Beschreibung	Höhe	
			Gesamt	Nutz
1	976020	ohne Einteilung	60	50
2	976034	Deckel	--	--

Einteilungen

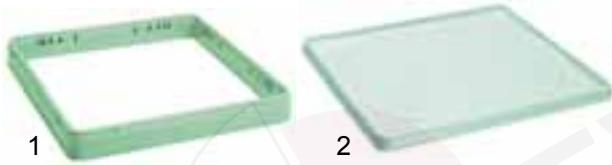

Pos.	B.-Nr	Größe	Pos.	B.-Nr	Größe
1	976023	4x4/110x110	3	976052	6x6/73x73
2	976021	5x5/89x89	4	976053	7x7/62x62

Zubehör



Abb.	Bestell-Nr.	Beschreibung	Größe
1	976016	Besteckkorbeinsatz	110x110x130
2	976011	Besteckkorbeinsatz	rund

Vorhänge

Passend für Comenda



Abb.	B.-Nr.	Maße (mm)	Einbau	Geräte-Typ	V.-Nr.
1	533101	690x390	Waschzone, Nachspülzone	Serie N	190902
2	533102	690x420	Einlauf, Auslauf	Serie N	190909



Abb.	B.-Nr.	Maße (mm)	Einbau	Geräte-Typ	V.-Nr.
1	510941	620x480	Einlauf, Auslauf	Serie S	190906
2	533103	620x250	Nachspritzzone	Serie SE	190913 331346

Passend für Hobart Vorhänge

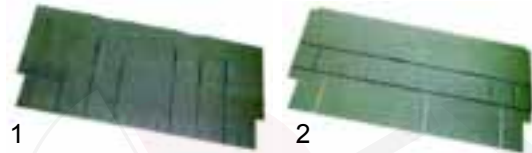
ohne Abbildung!

Pos.	B.-Nr.	Maße (mm)	Einbau	Geräte-Typ	V.-Nr.
1	533130	740x210			229436-2
2	533131	740x400			229436-1
3	533132	740x643		FTX	229436-3
4	533133	1095x210			229436-5
5	533134	1095x400			229436-4
6	533135	1095x643			229436-6
7	533137	640x210			231602-2
8	533138	640x380		CX	231602-1
9	533139	640x420			230781
10	533140	750x365			325346-4
11	533141	750x385			325346-8
12	533142	750x480			325346-5
13	533143	750x485		FTN	325346-1
14	533144	942x365			325346-3
15	533145	942x385			324346-7
16	533146	942x480			325346-6
17	533147	942x485			325346-2
18	533148	645x290			781284-1
19	533149	645x420		CR	781033-1
20	533150	645x430			781067-1

Vorhangstangen

ohne Abbildung!

Pos.	B.-Nr.	Maße (mm)	Einbau	Geräte-Typ	V.-Nr.
1	533151	740x8		FTX	229214
2	533152	1090x8			229924
3	533153	606x8			231540-3
4	533154	612x8			231540-1
5	533155	620x8		CX	137143
6	533156	680x8			231540-2
7	533157	750x8			325360-2
8	533158	942x8		FTN	325360-3
9	533159	645x8			325360-8
10	533160	655x8		CR	325360-7

Vorhänge

Passend für Krefft

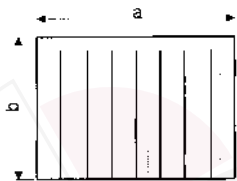

Pos.	B.-Nr.	axb (mm)	Einbau	Geräte-Typ	V.-Nr.
1	533120	660x550	Einlauf	CMX 1991-1999	610616
2	533121	660x500	Waschzone/ Nachspülzone		610867
3	533122	660x430	Trocknung		610617
4	533123	696x450	Auslauf		610945
5	533124	660x500			602268

ohne Abbildung!

Pos.	B.-Nr.	axb (mm)	Einbau	Geräte-Typ	V.-Nr.
1	533125	696x400	Einlauf	BMX	500002
2	533126	696x330	Waschzone/ Nachspülzone		500003
3	533127	696x500	Waschzone/ Auslauf		500001

Vorhangstreifen
Passend für Meiko

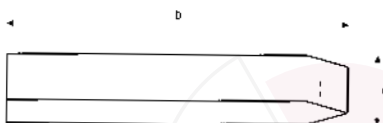

Pos.	B.-Nr.	axb (mm)	Einbau	Geräte-Typ	V.-Nr.
1	533161	75x250	Universal	B225K,	0475013
2	533162	75x330	Universal	B23K,	0475012
3	533163	75x380	Universal	K200K, K400K	0475011

Vorhänge
Passend für Meiko

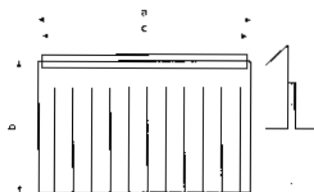

Pos.	B.-Nr.	axbc (mm)	Einbau	Geräte-Typ	V.-Nr.
1	533164	660x420x640	Trocknung	B-Tronik 6.'86 - 12.'93	8100244
2	533165	700x420x690	Auslauf		8100245
3	533166	730x420x720	Einlauf		8100242
4	533167	770x370x760	Nachspülzone		8100414
5	533168	770x420x760	Waschzone		8100243

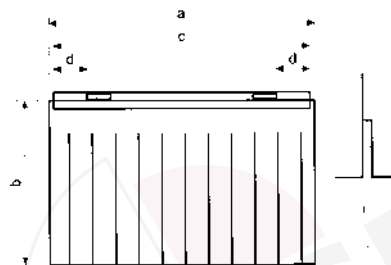

Pos.	B.-Nr.	axbxcxd (mm)	Einbau	G.-T.	V.-Nr.
1	533169	660x400x640x80	Einlauf/ Trocknung	B-Tronik ab 1.'94	8101676
2	533171	700x400x690x130	Auslauf		8101679
3	533172	730x400x720x75	Einlauf		8101670
4	533173	770x325x760x75	Waschzone		8101682
5	533174	770x400x760x75	Waschzone		8101673
6	533170	660x400x640x80	Einlauf		B-Tronik ab 1.'95

Aufgrund der großen Auswahl bezüglich der Meiko-Tabellen, bitten wir um Anfrage mit Geräte-Typ, Geräte-Nr. und Baujahr!

Passend für Winterhalter

ohne Abbildung!

Pos.	B.-Nr.	axb (mm)	Einbau	G.-T.	V.-Nr.
1	533180	610x480	PNN-Zone, Ende mit T-Zone	WKST	70003561
2	533181	650x350	PNN-Zone, Ende ohne T-Zone		70003098
3	533182	650x360	Waschzone		70003991
4	533183	650x440	P-Zone		70004395
5	533184	650x480	Einlauf		70003084
6	533185	566x300	Auslauf		70200289
7	533186	566x525	Einlauf	WKT1000	70200291
8	533187	620x100	Waschzone/ kurz		70200336
9	533188	640x486	Waschzone/ lang		70200343
10	533189	566x485	Einlauf	Bavaria	72000667
11	533190	650x350	Waschzone		72001068
12	533191	650x470	Waschzone/ Auslauf		72000671

Passend für Zanussi



Abb.	B.-Nr.	axb (mm)	Einbau	G.-T.	V.-Nr.
1	533105	575x420	Außen/ A	CT	046882
2	533106	640x430	Mittig		048042
3	533108	610x300	Mittig		068889



Abb.	B.-Nr.	axb (mm)	Einbau	G.-T.	V.-Nr.
1	533110	530x35	Mittig	CCT-1996	046883
2	533107	600x470	Außen	LSE	068891
3	533109	545x445		RT	0E5029 0E5227

Pumpen -Ersatzteile

nach FIR-Nummer sortiert



1
Laufrad



2
Gleitringdichtung



3
Pumpendeckeldichtung



4
Pumpendeckel



5
Kondensator

Pumpe FIR.-Nr. Gev.-Nr.	1 B.-Nr.	2 B.-Nr.	3 B.-Nr.	4 B.-Nr.	5 B.-Nr.
0214	500116	509010	510693	521718	521544 365014
0229	500019	521203	510695	509002	510510 365017
0235	500541	521266	510703	509002	521523 365017
0265	500388	501309	510702	521700	521500 365012
0267	500369	521208	510692	521702	521506 -
0267	500370	521211	510692	521702	521506 365021
0287	500327	511210	510695	521701	521501 365015
1204	500258	521218	510693	510551	510531 -
1204	500018	510604	510693	510551	510531 -
1205	500031	510612	510693	510551	510531 -
1211	500056	510601	510693	510551	510502 -
1214	500112	510601	510693	510551	510502 -
1217/A	500390	521209	510692	521702	521505 365014
1219	500004	510529	510692	510552	511187 -
1219/A	500017	510600	510692	510551	510508 365014
1221	500033	510607	510692	510552	521510 365014
1222	500009	511210	510692	510552	511187 365014
1225	500023	510602	510693	510551	521513 -
1225	500155	510602	510693	510551	510502 365016
1226	500533	521215	510693	510551	510502 -
1227	500323	521271	510693	510551	510502 -
1241	500271	510612	510693	510551	510531 -
1241	500111	510357	510693	510551	510531 -
1241	500119	510612	510693	510551	510531 365016
1241/3	500277	521272	510693	510551	510517 -
1243	500324	510357	510693	510551	510531 -
1243	500012	510604	510693	510551	510503 365014
1266/A	500254	521210	510692	521702	521509 365014
1267/A	500267	510605	510702	521701	521501 365015
1267	500261	510605	510702	521701	521503 365015
1268	500260	510609	510702	521701	521501 365015
1268/A	500262	510609	510702	521701	521503 365015
1270/A	500252	521210	510692	521702	521504 365014
1270/A	500256	521210	510692	521702	521508 365014
1272/A	500268	510605	510702	521701	521501 365014
1272/A	500270	510605	510702	521701	521503 365014
1286	500383	510609	510702	521701	521503 365015
1292/A	500027	510600	510692	521702	521505 365014
1293	500035	510601	510693	510551	510502 365014
1293	500325	510601	510693	510551	521517 365014
1293	500034	510601	510693	510551	510502 -
1295	500029	521213	510693	510551	521517 -
1295	500257	510520	510693	510551	510502 -

Pumpe FIR.-Nr. Gev.-Nr.	1 B.-Nr.	2 B.-Nr.	3 B.-Nr.	4 B.-Nr.	5 B.-Nr.
1295	500330	521213	510693	510551	510502 365014
1297	500003	510615	510693	510554	510512 365013
2204/D	500276	521219	510693	510551	510517 365019
2211	500037	521205	510695	509002	510384 365017
2212/N	500259	521201	510695	509002	510510 365017
2212-14	500518	521200	510695	509002	510510 365017
2220	500549	510529	510692	510552	521510 365017
2227	500552	511210	510692	521702	521504 365015
2228	500015	521203	510695	509002	510510 365017
2233/X1	500527	510608	510692	510552	521511 365014
2236/A	500118	510600	510692	521702	521509 365021
2241	500058	510602	510693	510551	510531 -
2246/A	500025	511210	510692	521702	521504 365015
2253	500125	510609	510702	521701	521502 365015
2254	500397	521216	510693	510551	521514 -
2254/S	500115	510602	510693	510551	521515 -
2256.14	500287	501313	510692	510552	521510 365021
2265	500263	510600	510692	521702	521505 365021
2265/A	500269	510600	510692	521702	521508
2282	500554	511210	510692	521702	521504 365014
2292	500010	510600	510692	521702	521506 365014
3911	500326	510610	510692	521702	521504 365014
3911	500553	510610	510692	521702	521504 365015
3911	500389	510610	510692	521702	521505 365014
3911	500038	510610	510692	521702	521507 365015
3911	500249	510610	510692	510552	521510 365015
3983	500550	511510	510692	510552	521510 365014
4134/C	500020	521207	510695	521701	521501 365015
4208/N	500399	521204	510695	509002	510384 365017
4213	500394	521206	510695	509002	500394 365012
4217/A	500264	510610	510692	521702	521506 -
4217/A1	500266	521263	510692	521702	521506 -
4223	500544	518067	510692	510552	521512 365021
4225	500400	521210	510692	521702	521505 365014
4225/1	500545	521214	510693	510551	510502 -
4225/2	500117	521214	510693	510551	510502 -
4226	50030	521202	510690	509002	510510 -
4233	500528	521212	510692	510552	521511 365021
4247	500127	510608	510692	521702	521505 365015
4293.23	500537	521217	510693	510551	521516 365021
7996	500278				-
B257.16	500396	521208	510692	521702	521506 365021

nach LGB-Nummer sortiert



1 Laufrad



2 Gleitringdichtung



3 Pumpendeckeldichtung



4 Pumpendeckel



5 Kondensator

Pumpe		1	2	3	4	5
LGB.-Nr.	Gev.-Nr.	B.-Nr.	B.-Nr.	B.-Nr.	B.-Nr.	B.-Nr.
AM.5225	500122	521238	510694	521712	521533	--
AM.5225	500536	521236	510694	521712	521533	365019
AM.5225	500376	521239	510694	521712	521536	365021
C.F.0938	500095	509010	510693	521717	521543	365021
FM4023	500513	521246	510703	521714	521539	365021
LC160	500091	521252	510703	510554	521547	--
LC160	500148	521252	510703	510554	521547	
T150	500001	509020	510703	510554	521547	365019
T170SX	500002	509020	510703	510554	521547	365019
T172	500542	521228	510703	521704	521523	365012
T173SX	500156	509031	510693	510552	521562	365021
T175SX	500543	509020	510703	510554	521548	365021
X5SX	500351	521239	510703	521710	--	365021
ZF115S	500353	521223	510703	521704	521519	365017
ZF115S	500329	521221	510703	521704	521520	365017
ZF1200S	500380	521245		521713	521538	--
ZF121D	500382	521229	510703	521704	521525	365012
ZF130S	500352	521224	510703	521704	521519	365012
ZF131D	500555	521228	510703	521704	521524	365012

Pumpe		1	2	3	4	5
LGB.-Nr.	Gev.-Nr.	B.-Nr.	B.-Nr.	B.-Nr.	B.-Nr.	B.-Nr.
ZF131S	500094	521220	510695	509002	510384	365012
ZF135S	500384	521232	510703	521707	521527	365013
ZF140S	500511	521230	510703	521706	521526	365017
ZF150	500538	521232	510703	521707	521527	365015
ZF150S	500362	521240	510694	521712	521536	--
ZF160	500331	521231	510703	521707	521527	365014
ZF170S	500539	509004	510703	521704	521519	365013
ZF170S	500510	521225	510703	521704	521519	365012
ZF270V	500381	521247	510702	521714	521539	365015
ZF320	500121	521248	510702	521714	521539	365014
ZF320	500120	521248	510702	521714	521539	365014
ZF320	500026	521248	510702	521714	521539	365014
ZF320V	500328	521246	510702	521714	521539	365014
ZF340	500512	521246	510702	521714	521539	365021
ZF400S	500361	521265	510709	510554	521563	365021
ZF522S	500360	521239	510693	521712	521536	365021
ZF650S	500379	521244	510694	521712	521536	
ZF800D	500377	521237	510694	521712	521534	--
ZF800S	500378	521242	510694	521712	521536	--

nach C&A-Nummer sortiert

Pumpe		1	2	3	4	5
C&A-Nr.	GEV-Nr.	B.-Nr.	B.-Nr.	B.-Nr.	B.-Nr.	B.-Nr.
4683	500184	509021	510692	521709	521530	365014
4715	500092	509021	510692	521709	521530	365014
7274	500188	509028	510693	521716	521541	365015
7274	500149	521233	510693	521716	521541	365015
7371	500275	521227	510692	521705	521522	365012
750	500024	521243	510693	521712	521536	--
7675	500181	509028	510693	521708	521528	365015
C.06116	500090	521237	510692	521709	521531	365014
C.10511	500032	509028	510693	521708	521528	365014
C.10511	500372	510623	510692	521709	521531	365014
C.14100	500501	509030	510693	521532	521711	--
C.1629	500366	521233	510693	521728	521529	365015
C.2532	500371	521231	510693	521711	521532	--
C.2868	500368	509021	510692	521709	521531	365021
C.3100	500113	521271	510692	521709	521351	--
C.397	500365	521266	510692	521704	521521	365012
C.424	500013	521243	510693	521712	521535	--

Pumpe		1	2	3	4	5
C&A-Nr.	GEV-Nr.	B.-Nr.	B.-Nr.	B.-Nr.	B.-Nr.	B.-Nr.
C.424	500373	521264	510693	521711	521561	--
C.4630	500185	521271	510692	521721	521549	365014
C.4710	500190	509021	510692	521709	521530	365014
C.4710	500085	510623	510692	521709	521531	365014
C.4757	500191	509021	510692	521709	521530	--
.5688	500367	521235	510692	521709	521531	--
C.5801	500114	509021	510692	521709	321531	365021
C.6300	500129	521227	510692	521705	521522	365012
C.6600	500272	521251	510693	521719	521546	--
C.6650	500273	521241	510693	521712	521535	--
C.7274	500183	521233	510693	521716	521560	365015
C.7279	500189	509028	510693	521716	521542	365015
C.7670	500180	521222	510692	521704	521518	365013
C.7670	500028	521226	510692	521704	521521	365013
C.9806	500187	521243	510693	521712	521537	--
C.9808	500186	521241	510693	521712	521537	--
MF450	500014	521238	510692	521709	521531	365021



