

Magnetventile/Solenoid valves

Scem/Parker



Abb. Pict.	Bestell-Nr. Order-No.	Beschreibung Description	Vergl.-Nr. Comp.-No.
1	370057	kpl., 3 Wege, 230VAC cpl., 3 ways, 230VAC	
2	370062	Ventilkörper Solenoid square pin	
3	370206	kpl., 1/8", 2 Wege, 230VAC cpl., 1/8", 2 ways, 230VAC	
4	371029	Magnetpule, 230VAC Magnetic coil, 230VAC	

Lucifer



Abb. Pict.	Bestell-Nr. Order-No.	Beschreibung Description	Vergl.-Nr. Comp.-No.
1	370053	kpl., 3 Wege, 230VAC cpl., 3 ways, 230VAC	
2	370061	Ventilkörper Solenoid square pin	
3	371031	Spule, 230VAC Coil, 230VAC	

ODE



Abb. Pict.	Bestell-Nr. Order-No.	Beschreibung Description	Vergl.-Nr. Comp.-No.
1	370203	kpl., 3 Wege, 230VAC cpl., 3 ways, 230VAC	
2	371150	Magnetspule, 230VAC Magnetic coil, 230VAC	
3	370168	1/8", 2 Wege, 230VAC 1/8", 2 ways, 230VAC	
4	371071	Magnetspule, 230VAC Magnetic coil, 230VAC	

Sirai

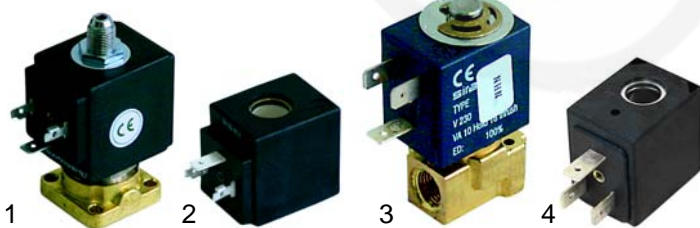

Abb. Pict.	Bestell-Nr. Order-No.	Beschreibung Description	Vergl.-Nr. Comp.-No.
1	370203	kpl., 3 Wege, 230VAC cpl., 3 ways, 230VAC	
2	371150	Magnetspule, 230VAC Magnetic coil, 230VAC	
3	370168	1/8", 2 Wege, 230VAC 1/8", 2 ways, 230VAC	
4	371071	Magnetspule, 230VAC Magnetic coil, 230VAC	

Magnetventile Zubehör/Solenoid valve accessories

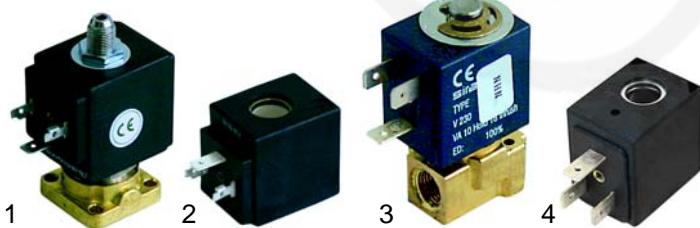

Abb. Pict.	Bestell-Nr. Order-No.	Beschreibung Description	Vergl.-Nr. Comp.-No.
1	371091	Stecker/klein Plug/small	
2	371090	Stecker/groß Plug/big	
3	371095	O-Ring/viton O-Ring/viton	
4	371100	O-Ring/Silikon O-Ring/Silicon	

Pressostate/Pressure switches



Abb. Pict.	Bestell-Nr. Order-No.	Beschreibung Description	Vergl.-Nr. Comp.-No.
1	541021	Pressostat, 3-pol Pressure switch, 3 poles	W10440
2	541089	Pressostat, 1-pol Pressure switch, 1 pole	

Hauptschalter/Main switches



Abb. Pict.	Bestell-Nr. Order-No.	Beschreibung Description	Vergl.-Nr. Comp.-No.
1	346104	0 - I, 20A	W10734
2	346105	0 - I, 32A	



Abb. Pict.	Bestell-Nr. Order-No.	Beschreibung Description	Vergl.-Nr. Comp.-No.
1	346100	I - 0 - II, 20A	W10735
2	346101	I - 0 - II, 32A	W10833
3	110205	Knebel Knob	W10744

Hauptschalter/Main switches



Abb. Pict.	Bestell-Nr. Order-No.	Beschreibung Description	Gerätetyp Device type	Vergl.-Nr. Comp.-No.
1	346055	Mikroschalter Micro switch		
2	346136	Kippschalter Tumbler		
3	345037	Schalter Switch	Orion	W10963

Niveauregler/Level controller

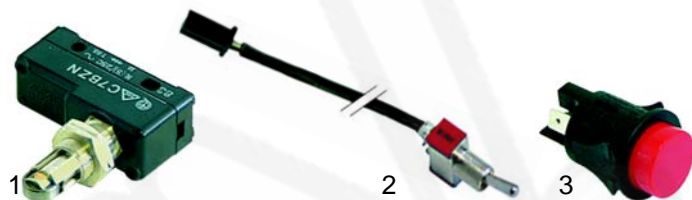

Abb. Pict.	Bestell-Nr. Order-No.	Beschreibung Description
1	400017	Niveauregler, RL30/1E-2C/11, 230V Level controller, RL30/1E-2C/11, 230V
2	400230	Niveauregler, RL40/1E/11, 230V Level controller, RL40/1E/11, 230V
3	380136	Socket, 11-pole Base, 11 poles

Schalter/Switches



Pos. Item	Bestell-Nr. Order-No.	Beschreibung Description	Einbaumaß Socket dim.
1	301002	Schalter, 2-pol Switch, 2 poles	30 x 22mm



Abb. Pict.	Bestell-Nr. Order-No.	Beschreibung Description	Gerätetyp Device type	Vergl.-Nr. Comp.-No.
1	400019	RL30/1E-2C/F, 230V		W10769
2	400530	RMF-C2SN, 230V	Mini Wega	W1018044
3	400020	Niveausonde, 150mm Level probe, 150mm		

Thermostate/Thermostats



Abb. Pict.	Bestell-Nr. Order-No.	Beschreibung Description	Vergl.-Nr. Comp.-No.
1	390431	2 polig, 40A 2 poles, 40A	W05154
2	390434	2 polig, 20A 2 poles, 20A	
3	390433	2 polig, 20A 2 poles, 20A	W10785

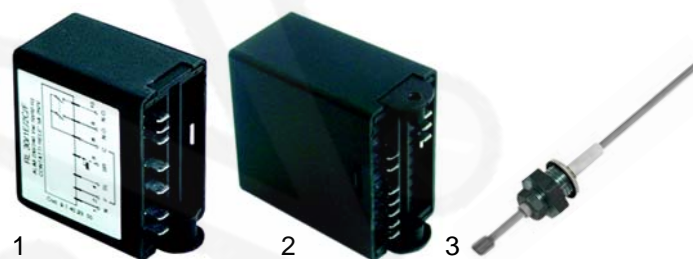

Abb. Pict.	Bestell-Nr. Order-No.	Beschreibung Description	Gerätetyp Device type	Vergl.-Nr. Comp.-No.
1	400537	RL/1E-2C/F Time Out	Orion	W10738
2	400538	LED Time Out	Sphera	

Flowmeter/Flowmeter

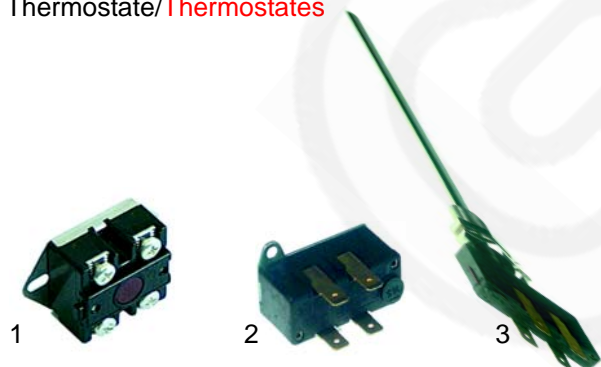

Abb. Pict.	Bestell-Nr. Order-No.	Beschreibung Description	Vergl.-Nr. Comp.-No.
1	400004	Flowmeter, 1/4" Flowmeter, 1/4"	W10785
2	400256	Stecker Plug	
3	400257	Zählrad Flowmeter reel	W10718
4	400258	Gehäusedichtung Case gasket	W10717

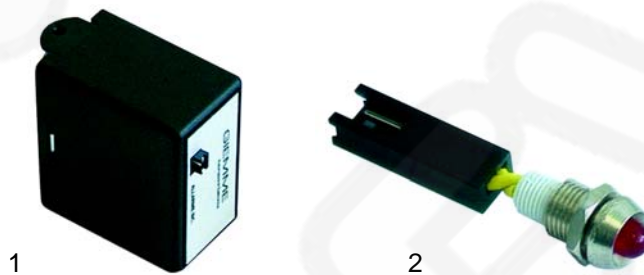
Tastaturen/Key push buttons



Pos. Item	Best.-Nr. Ord.-No.	Beschreibung Description	Gerätetyp Device type	V.-Nr. C.-No.
1	400506	Tastatur, 9.9.11.34 Key push button, 9.9.11.34	Nova, Antares	W11100 W18357



Abb. Pict.	Best.-Nr. Ord.-No.	Beschreibung Description	Gerätetyp Device type	V.-Nr. C.-No.
1	400354	Tastatur/5 Tasten Keyboard/5 push buttons	Eco, Junior, Airy, Atlas	W10839
2	400355	Tastatur/6 Tasten, DOS.TH 1Gr.+RL Keyboard/6 push buttons DOS.TH 1Gr.+RL		W10772

Tastaturen (Sphera)/Key push buttons (Sphera)



Abb. Pict.	B.-Nr. O.-No.	Beschreibung Description	Gerätetyp Device type	V.-Nr. C.-No.
1	400510	Tastatur (Wasser) Key push button (water)	Sphera	W5092
2	400511	Tastatur (EVD) Key push button (EVD)		W5093
3	400512	Tastatur (Wasser), 1 Gr. Key push button (water), 1 gr.		W5094



Abb. Pict.	B.-Nr. O.-No.	Beschreibung Description	Gerätetyp Device type	V.-Nr. C.-No.
1	400513	Tastatur (Tassenwärmer) Key push button (Cup warmer)		W5249
2	400514	Tastatur (EPU) Key push button (EPU)		W5250
3	400515	Tastatur (TRON) Key push button (TRON)		W7000

Elektronik/Electronics



Abb. Pict.	B.-Nr. O.-No.	Beschreibung Description	Gerätetyp Device type	V.-Nr. C.-No.
1	400379	Gieme, 1 - 3 Gruppen Gieme, 1 - 3 groups	Sphera	W5086
2	400544	Gicar, 1 - 3 Gruppen, 9.5.21.12 Gicar, 1 - 3 groups, 9.5.21.12		
2	400539	Gicar, 1 - 3 Gruppen, 9.5.21.16 Gicar, 1 - 3 groups, 9.5.21.16		

1 Passend für/Suitable for Wega

Heizkörper/Heaters

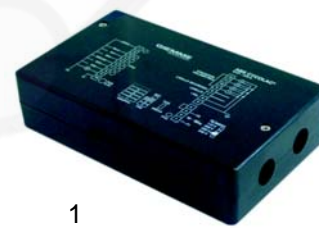

Abb. Pict.	Bestell-Nr. Order-No.	Beschreibung Description	Vergl.-Nr. Comp.-No.
1	417043	1 Gruppe, 1800W, 230V/400V 1 group, 1800W, 230V/400V	W10451
2	417154	1 Gruppe, 2700W, 230V/400V 1 group, 2700W, 230V/400V	W05151
2	417042	2 Gruppen, 2600W, 230V/400V 2 groups, 2600W, 230V/400V	W10456
2	417155	2 Gruppen, 3000W, 230V 2 groups, 3000W, 230V	W05152
3	417156	3 Gruppen, 3700W, 230V 3 groups, 3700W, 230V	W10461
3	417157	3 Gruppen, 5000W, 230V 3 groups, 5000W, 230V	W10466



Abb. Pict.	Bestell-Nr. Order-No.	Beschreibung Description	V.-Nr. C.-No.
1	417090	(Junior), 1500W, 230V (Junior), 1500W, 230V	
2	417089	(Mini, Wega), 1300W, 230V (Mini, Wega), 1300W, 230V	W17201
3	528001	Heizkörperdichtung/Klingerit Heater gasket/Klingerit	
3	528002	Heizkörperdichtung/Teflon Heater gasket/teflon	W10470
4	528021	Heizkörperdichtung/Teflon (Mini, Wega) Heater gasket/teflon (Mini, Wega)	

Kesseldichtungen/Pot gaskets



Abb. Pict.	Bestell-Nr. Order-No.	Beschreibung Description
1	528150	Kesseldichtung Pot gasket
2	528151	Kesseldichtung/Teflon Pot gasket/teflon

Manometer/Manometer

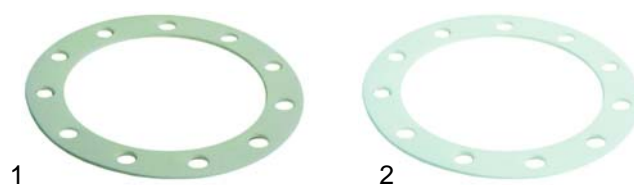

Pos. Item	Bestell-Nr. Order-No.	Beschreibung Description	Vergl.-Nr. Comp.-No.
1	541223	Manometer/Doppelskala Manometer/double scale	W10790

Ventile/Valves



Abb. Pict.	Bestell-Nr. Order-No.	Beschreibung Description
1	529312	Sicherheitsventil, 1,8bar, 3/8" Safety valve, 1,8bar, 3/8"
2	529316	Sicherheitsventil/verplombt, 1,8bar, 3/8" Safety valve/sealed, 1,8bar, 3/8"
3	529303	Entlüftungsventil/CNS, 1/4" Empty valve/stainless steel, 1/4"
4	529304	Entlüftungsventil, 1/4" Empty valve, 1/4"
5	529361	Cu-Dichtung, 1/4" Cu-gasket, 1/4"
6	529349	Cu-Dichtung, 3/8" Cu-gasket, 3/8"



Abb. Pict.	Bestell-Nr. Order-No.	Beschreibung Description
1	528790	Rückschlagventil, 3/8" Non-return valve, 3/8"
2	528936	Expansionsventil Expansion valve
3	528937	Expansionsventil (regulierbar) Expansion valve (adjustable)

Wasserstandsglas/Level glass



Abb. Pict.	Bestell-Nr. Order-No.	Beschreibung Description	Vergl.-Nr. Comp.-No.
1	529407	Wasserstandsglas, 170 x 11mm Level glass, 170 x 11mm	W10559
2	529408	Wasserstandsglasdichtung Level glass gasket	W10557
3	529409	Druckscheibe Pressure washer	W10560
4	529355	Plastikkugel Plastic ball	W10561

Hähne/Taps

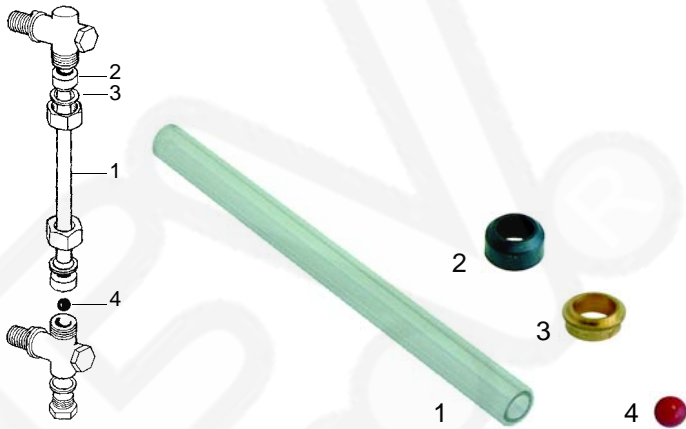

Abb. Pict.	Best.-Nr. Ord.-No.	Beschreibung Description	Gerätetyp Device type	V.-Nr. C.-No.
1	529621	Hahn/kpl. (Dampf/Wasser) Tap/cpl. (steam/water)		W10582 + W10565
2	111090	Knebel (Dampf) Knob/cpl. (steam)	Orion	W10569
3	111156	Knebel (Wasser) Knob (water)	Orion	W10568
4	111091	Knebel (Dampf) Knob (steam)		
5	111152	Knebel (Wasser) Knob (water)		
6	111158	Knebel (Dampf), 45mm Knob (steam), 45mm	Atlas	W10572
7	111157	Knebel (Wasser), 45mm Knob (water), 45mm	Atlas	W10571

Wasserfüllventile/Water intake valves



Abb. Pict.	Bestell-Nr. Order-No.	Beschreibung Description	Vergl.-Nr. Comp.-No.
1	529631	Wasserfüllventil/kl. Water intake valve/cpl.	
2	529632	Wasserfüllventil/kl. Water intake valve/cpl.	W05166
3	111092	Griff Handle	W10518

Hähne/Taps



Abb. Pict.	Bestell-Nr. Order-No.	Beschreibung Description	Vergl.-Nr. Comp.-No.
1	528308	Dichtung, 15 x 4 x 4mm Gasket, 15 x 4 x 4mm	W10652
2	528312	Dichtung Gasket	W10649
3	528313	Wellendichtung Shaft gasket	W10653
4	529719	Feder Spring	W10648



Abb. Pict.	Bestell-Nr. Order-No.	Beschreibung Description	Vergl.-Nr. Comp.-No.
1	528309	Dichtung Gasket	W10527
2	528308	Kolbendichtung Piston gasket	W10652
3	528310	Kolben Piston	W10546
4	528311	Feder Spring	W10545

1 Passend für/Suitable for Wega

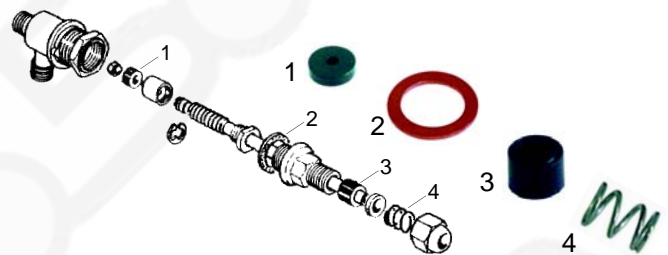
Rohre/Pipes

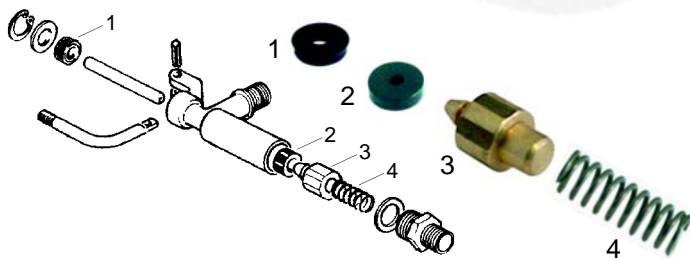

Abb. Pict.	Bestell-Nr. Order-No.	Beschreibung Description	Gerätetyp Device type	V.-Nr. C.-No.
1	529775	Dampfrohr Steampipe		
2	529773	Dampfrohr/CNS Steampipe/stainless steel		
3	529860	Wasserrohr Waterpipe		
4	529778	Dampfrohr Steampipe	Spera	
5	529777	Dampfrohr Steampipe	ECO Plus	W10439

Rohr-Zubehör/Pipe accessories

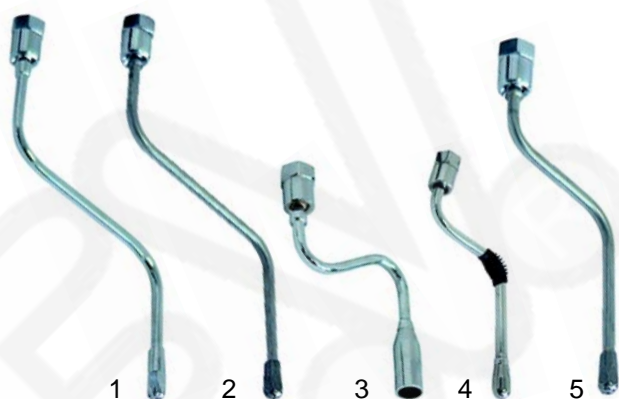

Abb. Pict.	Best.-Nr. Ord.-No.	Beschreibung Description	Gerätetyp Device type	Vergl.-Nr. Comp.-No.
1	528210	Dichtung/Klingerit Gasket/klingerit		W10650
1	528314	Dichtung/Teflon Gasket/teflon		
2	529719	Feder Spring		W10648
3	529718	Pressscheibe Pressure washer		W10574
4	529412	O-Ring O-ring		W10675
5	528938	Überwurfmutter Union nut		
6	529735	Feder Spring	Spera, ECO Plus	W05158
7	529738	Buchse Bush	Spera, ECO Plus	W05157
8	529739	O-Ring O-ring	Spera, ECO Plus	W05156

Rohre/Pipes

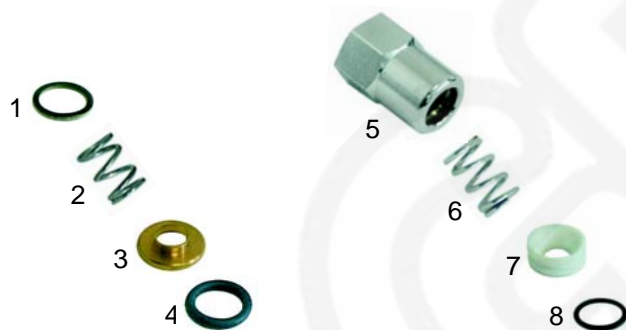

Pos. Item	Bestell-Nr. Order-No.	Beschreibung Description	Gerätetyp Device type
1	529770	Dampfhahn, cpl. Steam tap	Mini Wega
2	111151	Knebel Knob	Mini Wega

Ablaufwanne/Drain tap

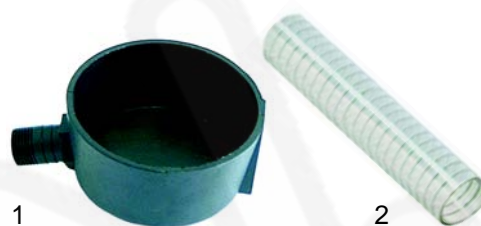

Pos. Item	Bestell-Nr. Order-No.	Beschreibung Description	Vergl.-Nr. Comp.-No.
1	528600	Ablaufwanne Drain tap	W10795
2	520072	Ablaufschlauch, 3/8", VPE 5m Outflow hose, 3/8", pack 5m	
2	520036	Ablaufschlauch, 3/8", VPE 30m Outflow hose, 3/8", pack 30m	

Gruppe/Group

1
Passend für/Suitable for Wega



Abb. Pict.	Bestell-Nr. Order-No.	Beschreibung Description	Abb. Pict.	Bestell-Nr. Order-No.	Beschreibung Description	Abb. Pict.	Bestell-Nr. Order-No.	Beschreibung Description
1	528519	Endkappe Ending cap	12	528528	Buchse Bush	23	528508	Cu-Dichtung Cu-gasket
2	528520	Cu-Dichtung Cu-gasket	13	528494	Dichtung, 13 x 4 x 4mm Gasket, 13 x 4 x 4mm	24	528537	Strahlbrecher Perlator
3	528521	Feder Spring	14	528529	Scheibe Washer	25	528538	Ablaufendstück Drain end part
4	528522	Scheibe Washer	15	528530	Hutmutter, 11mm Hat nut, 11mm	26	528939	Welle, exzentrisch Shaft, eccentric
5	528326	Filter Filter	16	528524	Dichtung (Teflon) Gasket (teflon)	27	528495	Dichtung Gasket
6	528321	Buchse Bush	17	528531	Hutmutter, 12mm Hat nut, 12mm	28	528541	Buchse Bush
7	528486	Düse Nozzle	18	528532	Schraube/lang, Infusion Srew/long, infusion	29	528542	Feder Spring
8	528523	Trompete Trumpet	19	528533	Feder Spring	30	528940	Hebel Lever
9	528525	O-Ring O-ring	20	528534	Kollektor Commutator	31	528941	Griffstange Handle rod
10	528526	Feder Spring	21	528535	Hutmutter Hat nut	32	528942	Griff Handle
11	528527	Welle Shaft	22	528475	Feder Spring			

Gruppe/Group

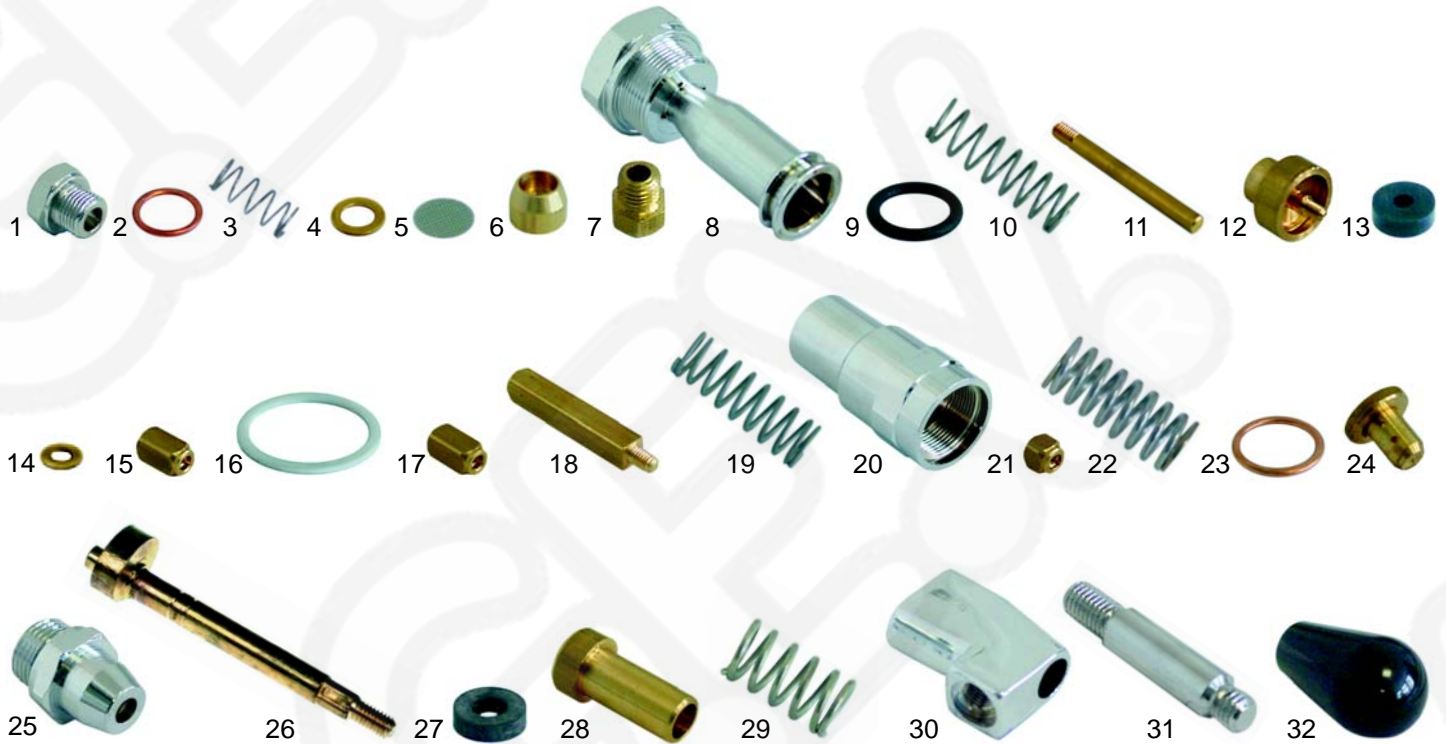
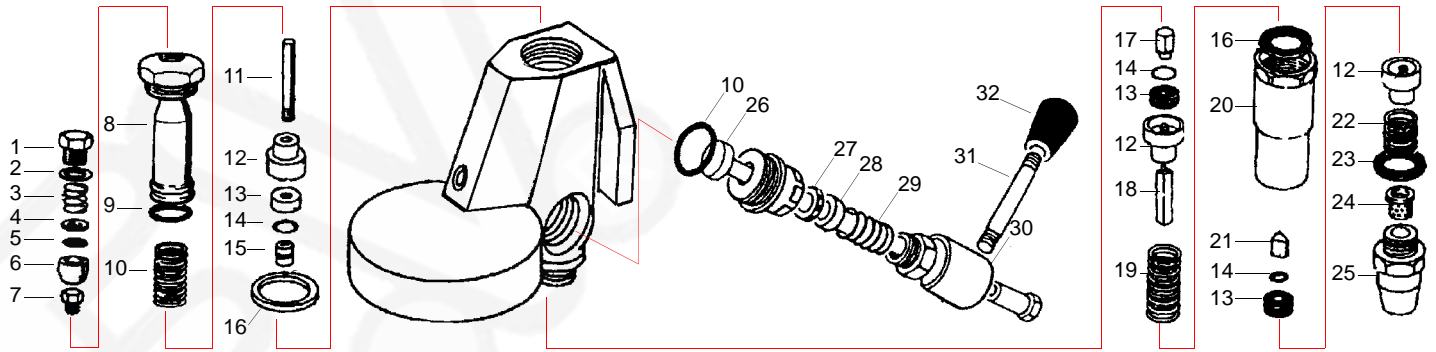
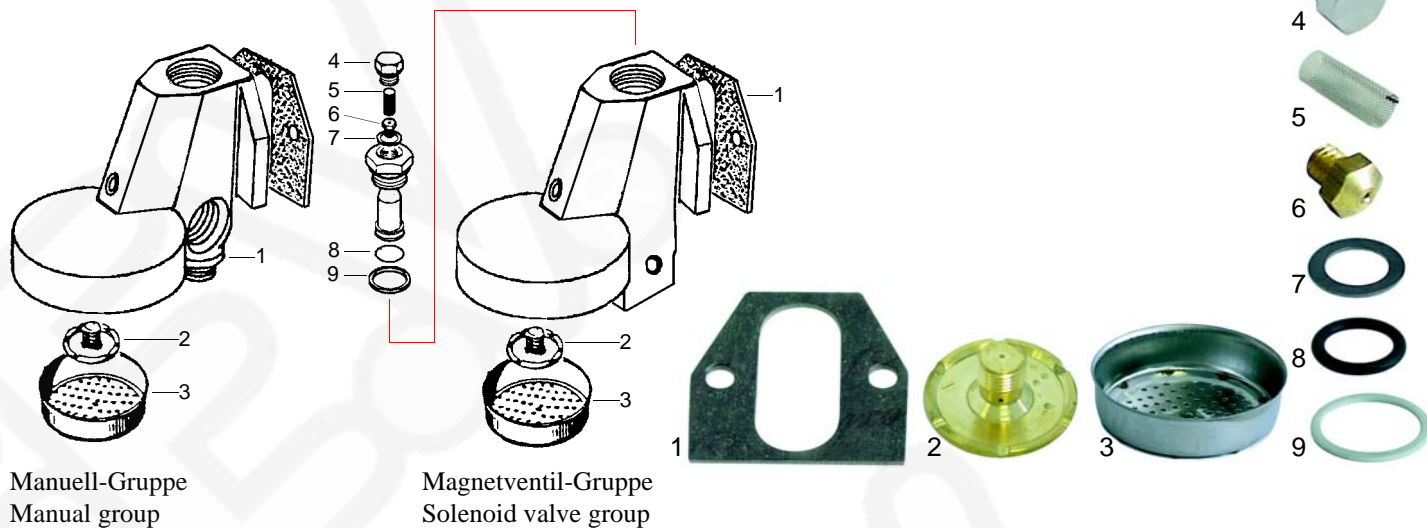

Manuell-Gruppe
Manual group

Magnetventil-Gruppe
Solenoid valve group

Abb. Pict.	Bestell-Nr. Order-No.	Beschreibung Description	Vergl.-Nr. Comp.-No.
1	528943	Gruppendichtung Group gasket	
2	529081	Verteiler Divider	W10320
3	529080	Dusche Shower	W10401
4	528944	Schraubkappe Screw cap	W10306
5	528946	Filter Sieve	W10307

Abb. Pict.	Bestell-Nr. Order-No.	Beschreibung Description	Vergl.-Nr. Comp.-No.
6	528947	Düse Nozzle	W10308
7	528945	Dichtung Gasket	W10309
8	528525	O-Ring O-ring	W10311
9	528524	Dichtung Gasket	W10643

Siebträgerdichtungen, Filter/Filter holder gaskets, filters



Abb. Pict.	Bestell-Nr. Order-No.	Beschreibung Description	Vergl.-Nr. Comp.-No.
1	528033	Distanzeinlage, 71 x 68mm Shim gasket, 71 x 68mm	
2	528030	Siebträgerdichtung, 73 x 57 x 8mm Filter holder gasket, 73 x 57 x 8mm	W10321
2	528031	Siebträgerdichtung, 73 x 57 x 8,5mm Filter holder gasket, 73 x 57 x 8,5mm	W10323
2	528032	Siebträgerdichtung, 73 x 57 x 9mm Filter holder gasket, 73 x 57 x 9mm	W10322
3	529012	Sieb, 1 Tasse (6g) Filter, 1 cup (6g)	

Abb. Pict.	Bestell-Nr. Order-No.	Beschreibung Description	Vergl.-Nr. Comp.-No.
3	529011	Sieb, 1 Tasse (7g) Filter, 1 cup (7g)	W10325
4	529014	Sieb, 2 Tassen (12g) Filter, 2 cups (12g)	
4	529013	Sieb, 2 Tassen (14g) Filter, 2 cups (14g)	W10326
5	529023	Blindfilter Blindfilter	
6	529079	Filterfeder Filter spring	W10327

Siebträger/Filter holder



Abb. Pict.	Bestell-Nr. Order-No.	Beschreibung Description	Vergl.-Nr. Comp.-No.
1	529058	Siebträger, 3/8", M12 Filter holder, 3/8", M12	W11775
2	529068	Siebträgergriff, M12 Filter holder handle, M12	W10329

Abb. Pict.	Bestell-Nr. Order-No.	Beschreibung Description	Vergl.-Nr. Comp.-No.
3	529045	Siebträgergriff, M12 Filter holder handle, M12	

Ausläufe/Spouts



Abb. Pict.	Bestell-Nr. Order-No.	Beschreibung Description	Vergl.-Nr. Comp.-No.
1	529002	3/8", 1 Weg, gerade/kurz 3/8", 1 way, straight/short	
2	529001	3/8", 1 Weg, gerade/lang 3/8", 1 way, straight/long	
3	529005	3/8", 1 Weg, gebogen/kurz 3/8", 1 way, curved/short	
4	529003	3/8", 1 Weg, gebogen/lang 3/8", 1 way, curved/long	

Abb. Pict.	Bestell-Nr. Order-No.	Beschreibung Description	Vergl.-Nr. Comp.-No.
5	529004	3/8", 1 Weg, gebogen/geschlossen 3/8", 1 way, curved/closed	W10670
6	529008	3/8", 2 Wege, Abstand 44mm 3/8", 2 ways, distance 44mm	
7	529007	3/8", 2 Wege, Abstand 55mm/kurz 3/8", 2 ways, distance 55mm/short	W10671
8	529006	3/8", 2 Wege, Abstand 55mm/lang 3/8", 2 ways, distance 55mm/long	